

MAGNETIC EQUIPMENT FOR CONVEYANCE

MAGNETIC TOOLS & EQUIPMENT FOR MINING OPERATION
 LIFTING MAGNET
 MAGBOP®
 OHP & SLOUSE CONVEYANCE EQUIPMENT
 ENVIRONMENTAL EQUIPMENT
 MAGNETIZER AND DEMAGNETIZER
 MAGNETIC EQUIPMENT FOR CONVEYANCE
 MAGNETIC SEPARATORS
 POWERFUL MAGNETIC SEPARATORS
 MEASURING TOOLS
 MEASURING INSTRUMENTS
 MAGNETIC MATERIALS

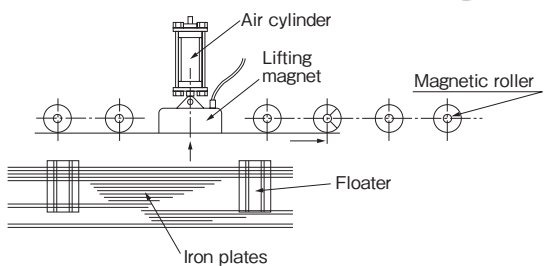
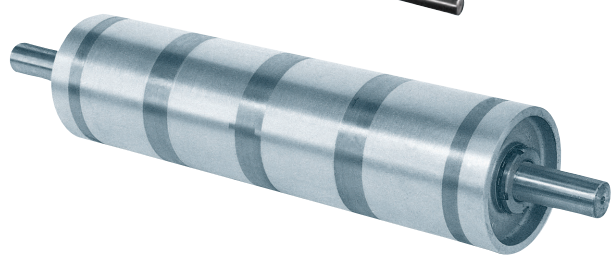
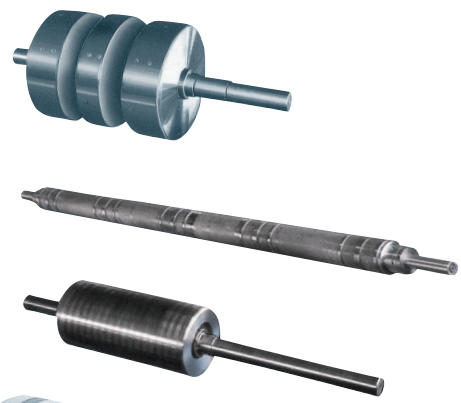
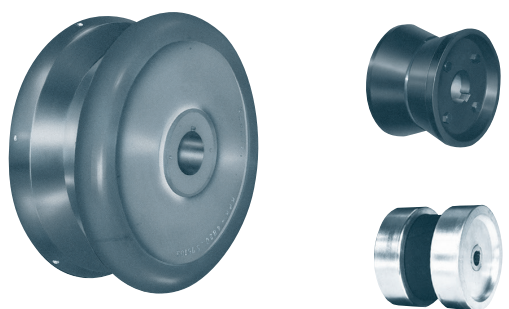
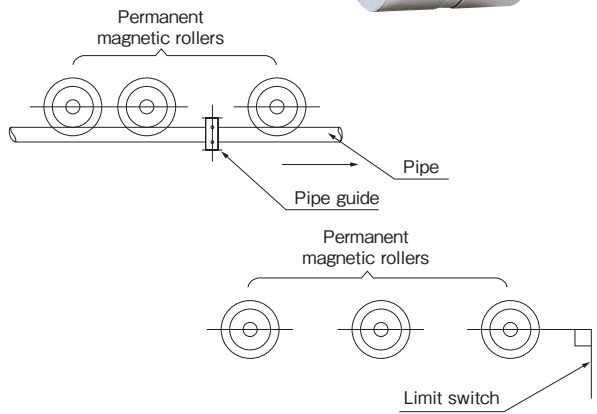
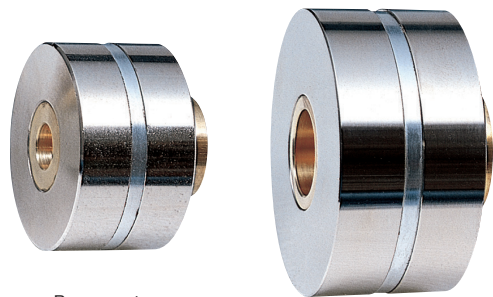

Model KPR-A SMALL PERMANENT MAGNETIC ROLLER

The magnetic rollers that are frequently used for conveyance (including conveyance stopping) of steel pipes and steel plates have been standardized and kept in stock.

⚠ Precaution for use
 These products are assembled by bonding. For high temperature services and rubber lining, structural restrictions must be taken into consideration. Please contact us for more information.

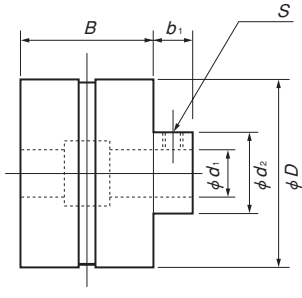
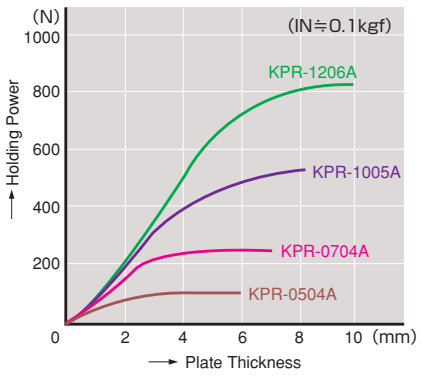

Model	Dimensions						Mass
	D	B	d ₁	b ₁	S	d ₂	
KPR-0504A	50 (1.96)	35 (1.37)	12 (0.47)	10 (0.39)	M5 (0.19)	22 (0.86)	0.45kg/0.99 lb
KPR-0704A	70 (2.75)	40 (1.57)	20 (0.78)	12 (0.47)	M6 (0.23)	35 (1.37)	1.0 kg/2.20 lb
KPR-1005A	100 (3.93)	50 (1.96)	30 (1.18)			45 (1.77)	2.4 kg/5.29 lb
KPR-1206A	120 (4.72)	60 (2.36)	40 (1.57)	16 (0.62)	M8 (0.31)	60 (2.36)	3.8 kg/8.39 lb

Model KER ELECTROMAGNETIC ROLLER

[Application]
 This model employs a powerful electromagnet and its optimum design helps increase the efficiency of conveyance of steel pipes and steel plates.

[Features]
 ● The electromagnetic rollers can easily be turned on and off or adjusted in magnetic force for easy handling of iron products.

<Specification>
 ● For the standard type dimensions, refer to the electromagnetic pulley KER.

Model KPR PERMANENT MAGNETIC ROLLER FOR THIN STEEL SHEET

[Application]
 Most suitable for holding thin steel sheets of 0.2 to 0.4 mm thick such as printing rollers.

<Manufacturing range>
 Diameter: φ100-200mm
 Length: 300-1000mm
 For a length longer than 800 mm, the diameter needs to be φ180 mm or larger.

<Revolution>
 750 rpm max.

Remarks) In case balance adjustment is required, please contact us.

※ Please see the Facsimile Communication Form (Selection Data) on page 175 also.

Model KRA MAGNETIC RAIL

The magnetic rails are tools that are installed on the backside of belts to convey various items such as products and press scraps to assist such conveyance. These rails are used to improve the work efficiency.

[Application]

Recommended for such operations as vertical and inclined conveyance of filled cans and empty cans, conveyance of press scraps and chips, leak inspection of aerosol cans and belt conveyance in manufacturing processes.

[Features]

- Two types, permanent magnetic rails and electromagnetic rails are available according to operations.
- Easy handling of products and goods. No fixtures are necessary and products and goods to convey are not damaged.

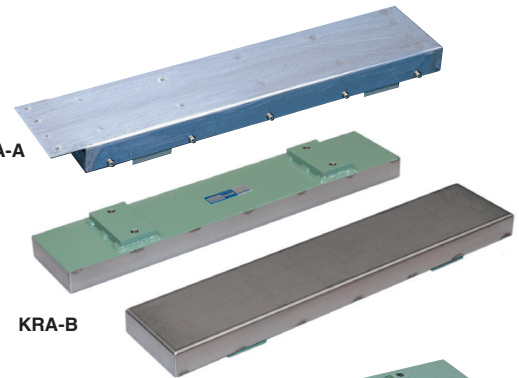
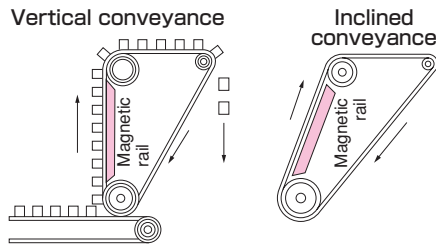

An example of handling thin steel sheets

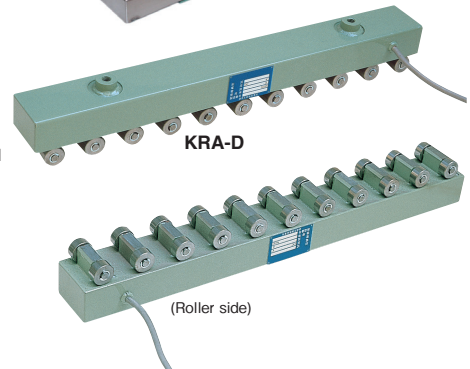
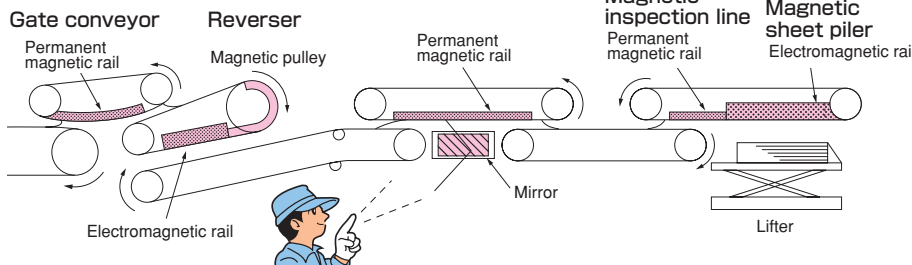

Reject gate conveyor

Sorter

- [Application]**
- Can be used in lines to accept and reject inspected sheets.
 - The flow of sheets can be branched to two directions.

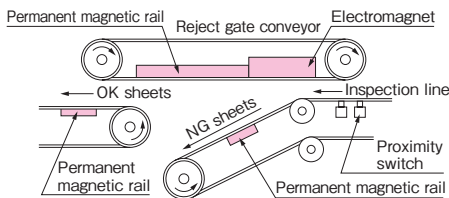

Backing conveyor

Reverser

- [Application]**
- Can be used in such operations as turning sheets or reversing the sheet flowing directions to inspect the backside of thin steel sheets and to shorten the drying line in painting shops and for alignment machines.

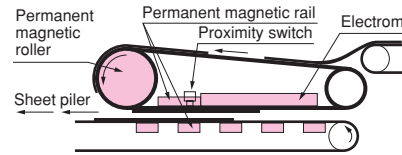

Sheet piler

Steel sheet piler

- [Application]**
- Sheets can be piled smoothly by use of a magnetic conveyor.

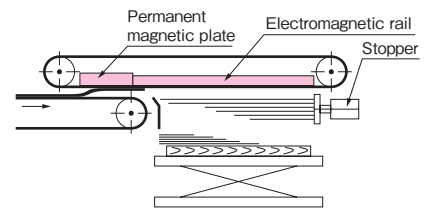

Permanent magnetic rail

KRA-A permanent magnetic rail

A magnetic plate is mounted inside a stainless steel case. Can be easily connected to the poles of a permanent magnetic pulley. Used for elevator type magnetic conveyors.

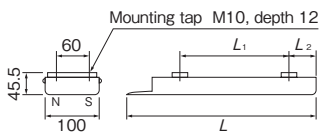

Model	L	L ₁	L ₂	Mass
KRA-A 500	500 (19.6)	300 (11.8)	80 (3.15)	9.5kg/ 21 lb
KRA-A1000	1000 (39.4)	600 (23.6)	200 (7.87)	19.0kg/ 41 lb

Electromagnetic rail

KRA-C type electromagnetic rail

Used for magnetic conveyors that receive steel sheets that have been conveyed in the inverted posture by a piler. Rating: 180 VDC, continuous

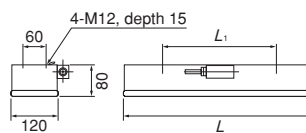

Model	Current	L	L ₁	Mass
KRA-C 500	0.52A	500 (19.6)	300 (11.8)	25kg/ 55 lb
KRA-C1000	1.01A	1000 (39.4)	270 (10.6) × 3	50kg/ 110 lb

KRA-B permanent magnetic rail

Poles of a magnet are projecting to the inside of a stainless steel case. The holding power via a belt is strong. Used for magnetic conveyors that convey thin steel sheets in the inverted posture.

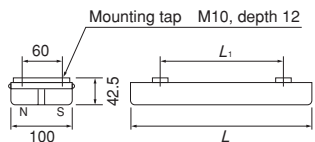

Model	L	L ₁	No. of Taps	Mass
KRA-1050B	500 (19.6)	300 (11.8)	4	13kg/ 29 lb
KRA-10100B	1000 (39.4)	270(10.6) × 3	8	27kg/ 60 lb

KRA-D electromagnetic rail with rollers

An electromagnetic rail having rollers. Used to prevent drooping of steel sheets after shearing machines.

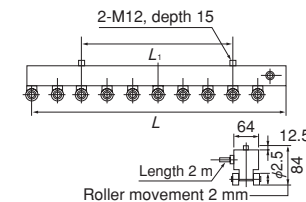

■ Rectifier RH-MW type
Input 200 VAC, single-phase output 0-180 VDC, 5 A/10 A

Model	L	L ₁	No. of Taps	Mass
KRA-D50	550 (21.6)	350 (13.7)	180 VDC, 90W	10kg/ 22 lb
KRA-D75	800 (31.5)	500 (19.6)	180 VDC, 148W	15kg/ 33 lb

*Sizes not listed above are also available upon request.

MAGNETIC TOOLS & EQUIPMENT FOR FURNACE OPERATION
LIFTING MAGNET
MAGBORG
MAGNETIZER AND ENVIRONMENTAL EQUIPMENT
MAGNETIZER
MAGNETIC EQUIPMENT FOR CONVEYANCE
MAGNETIC SEPARATORS
POWERFUL MAGNETIC SEPARATORS
MEASURING INSTRUMENTS TOOLS
MAGNETIC MATERIALS

Model PME MAGNETIC CONVEYOR MAGCON

[Application]

The Magcon is a magnetic conveyor having permanent magnets arranged under the belt and is mainly used to convey iron parts and press scraps upward or downward.

[Features]

- High-performance permanent magnets and optimum design. Practically no diminishing of the magnetic force during its life. (Magnetic force diminishes less than 2% over 10-year period)
- Simplified mechanism for trouble-free operations.
- The portable type and inclining type are employed simultaneously to meet a wide variety of operations.
- Requiring less space, the Magcon can be utilized efficiently in small space in factories.
- Can be used to connect other up-down conveyor lines when used as an intermediate conveyor link.
- The time to transfer products between processes can be shortened.

An example of Magcon fabrication 1

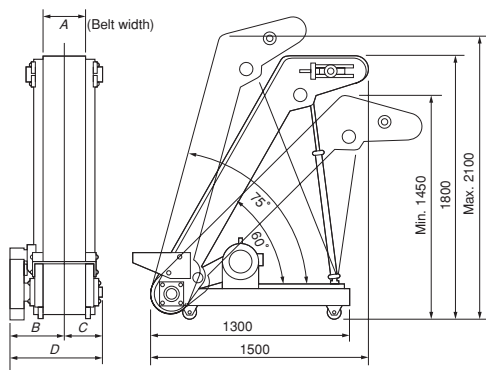

- Belt speed: 20 m/min
 - Belt: Oil-resistant conveyor belt
 - Power source: 3-phase, 220 VAC (for motor)
 - Magnet: Sintered magnet having high holding power
- Notes: ※ A feeder hopper will be installed upon request.
 ※ The head pulley can be a magnetic pulley upon request. (It picks up magnetic substances on the floor.)

※ Various types of the Magcon for various operations including vertical conveyance are designed and fabricated according to your needs.

An example of Magcon fabrication 2



[mm (in)]

Model	A	B	C	D	Motor
PME-20	200 (7.87)	280 (11.0)	210 (8.26)	480 (18.9)	0.75kW
PME-30	300 (11.8)	330 (12.9)	280 (11.0)	580 (22.8)	
PME-45	450 (17.7)	405 (15.9)	335 (13.1)	740 (29.1)	
PME-60	600 (23.6)	480 (18.9)	410 (16.1)	840 (33.1)	1.5 kW

Examples of special fabrication of magnetic equipment for conveyance

COIL OPENER

MCO-P

SHEET FEEDER

AFR

[Application]

An opener of strip coil is used for labor saving and safety of workers. This opener is used to automatically set the leading edge of coil in the pinch rollers in various factories such as steel mills.

This opener is used in strip coil leveler lines, slitter lines, plaiting lines, surface treatment lines, forming lines, etc. to contribute to labor saving.

Applicable strip coil:

- Material: Ordinary steel plate, silicon steel, colored steel plate, plated steel, surface coated steel, etc.
- Width: 10 - 2,000 mm
- Thickness of plate: 0.2 - 3.0 mm
- Threading speed: Normally 30 m/min

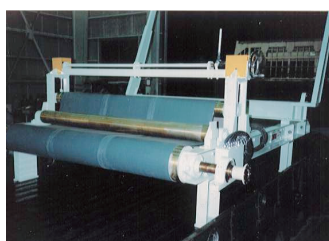

[Application]

Suitable for feeding silicon steel for iron core into a baking furnace in factories such as electric appliance manufacturing or feeding thin steel sheets to a press machine, or for transferring cut-out or punched plates.

[Features]

- Powerful permanent magnets are employed. The magnetic force diminishes little and no power source for excitation is required.
- A simplified mechanism with roller rotating motion and cylinder reciprocating motion combined, which is less likely to become a cause of failure.
- Each time a plate is fed out, the cylinder moves up and down. This feature makes this feeder suitable for operations where a relatively small number of sheets is handled.
- Light weight and compact for easy installation and handling.

