

POWERFUL MAGNETIC SEPARATORS

For foods and chemicals. Supporting high purity of liquids and granular materials.

In recent years, a need to remove foreign matter, to improve purity and to increase the safety level has become an essential requirement in foods making and processing. KANETEC has been offering an assistance and contribution in the fields of separating and eliminating magnetic foreign matter by utilizing its superb magnetic technology. KANETEC also makes full use of its application technology of rare earth magnets of strong magnetic force to enable collection of weak magnetic substances. The lineup of separators has been expanded to meet various requirements and operations including shapes of passing foods in liquid or viscous liquid, joint specifications, forced feed and high temperature to back up the food processing system.

For powder and granular materials

Model	Examples of Application
PCMG-2530	Candy raw materials, coffee beans, herb medicines
PCMG-C25	Pickled vegetables, tablets, plastic pellets
PCMG-C20A	Soybeans, peppers, powder soap
PCMG-AC15	Frying flour, powder milk, titanium powder
PCMG-A1611W-S	Dry granules
PCMG-A2323	Adzuki beans, flavored rice sprinklers, chemicals
PCMG-A1212-S	Spices, buck wheat flour, sesame
PCMG-T2020W	Starch, soap, plastic pellets
PCMG-U2525M-S	Baked salt
PCMG-A7530-S	Boiled beans, dry salty-simmered bamboo shoots (menma), sugar materials on conveyor
CPM	Konjak flour, grape sugar powder, fertilizer
PCMP-150W-S	Wheat flour, potato starch, feed
PCMP-UD200W-S	Wheat flour
PCMP-300	Spice materials, gunpowder, chemicals
PCMP-AR1222	Curry powder, powder wasabi, flavor
PCMD-1630	Polished rice, barley & wheat, beans, coffee beans
PCMN-TF1225-S	Ita Nori (sheet laver)
PCMH2-UD30-S	Wheat flour
PCMR-50-S	Dry granules

Food

Chemical

Medicine

Cosmetics

Feed and fertilizer

Glass

Ceramics

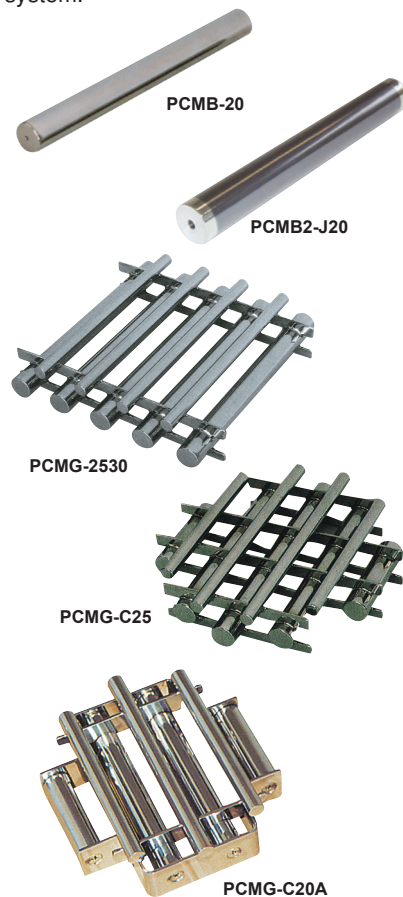

Features

- High grade finish of sanitary specification.
- Models of various sizes are available.
- With a strong magnet having a property value of 1,200 mT (12 kG) or 1,350 mT (13.5 kG) or over built in, a strong magnetic force of a surface maximum magnetic flux density of 800 mT (8 kG) or 1,000 mT (10 kG) or over collects iron and stainless steel particles mixed in raw materials.
- Since permanent magnets that maintain a strong magnetic force almost perpetually are used, the running cost can be reduced significantly.
- Models that can be installed in liquid are also available.

For viscous materials and liquids

Model	Examples of Application
PCML-10-S	Honey, chili oil, fermented soybean tare
PCML-T15	Dairy products, ketchup, sausage
PCMS-T15	Mayonnaise, steak sauce, paste
PCMY	Noodle soup, sauce, syrup
PCMH-T15	Curry roux, jam, doubanjiang (chili garlic sauce)
PCMH2-T15	Soup, fluid egg, liquid spice
PCMH-T20	Juice containing flesh fruit, miso, minced meat
PCMH-25	Juice, miso, minced meat
PCMH-A100-S	Pulp liquid
PCMF	Chocolate, cream

Food

Chemical

Features

- High grade finish of sanitary specification.
- Models of various sizes are available to meet various mounting pipe diameters.
- With a strong magnet having a property value of 1,200 mT (12 kG) or 1,350 mT (13.5 kG) or over built in, a strong magnetic force of a surface maximum magnetic flux density of 800 mT (8 kG) or 1,000 mT (10 kG) or over collects iron and stainless steel particles mixed in raw materials.
- Since permanent magnets that maintain a strong magnetic force almost perpetually are used, the running cost can be reduced significantly.
- Compact, requiring a small installation space. Easy and simple operation (periodical removal of caught iron).
- A heat-resistant, powerful type is also available that can be used with high temperature fluids continuously without significant deterioration.

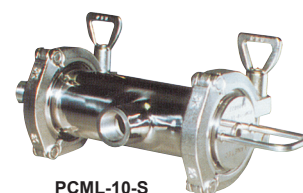

PCML-10-S

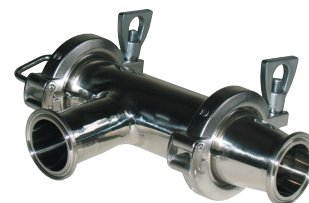

PCML-15



PCMS-T15

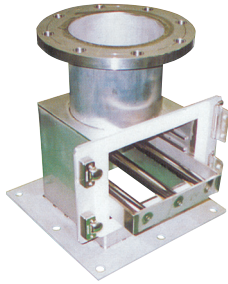

PCMP-150W-S



PCMR-50-S

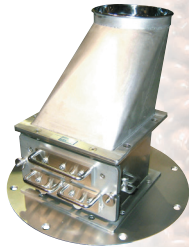

PCMP-UD200W-S

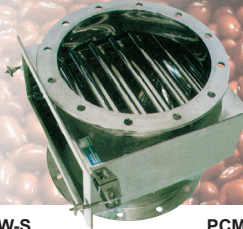

PCMP-300

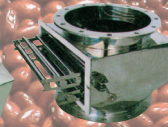

PCMG-A2323

PCMG-T2020W

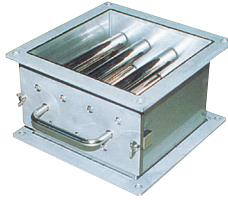

PCMG-U2525M-S

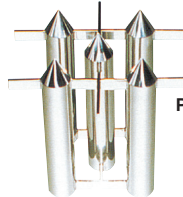

PCMG-AC15

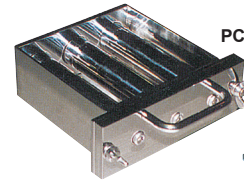

PCMG-A1212-S

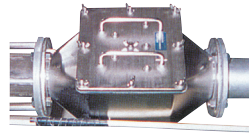

PCMP-65W



PCMG-A1611W-S



CPM

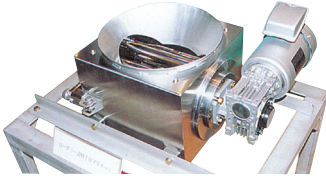

PCMP-AR

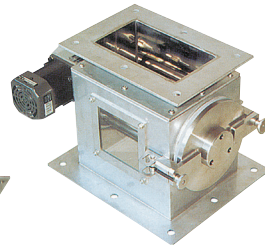

PCMP-AR1222



PCMN-TF1225-S

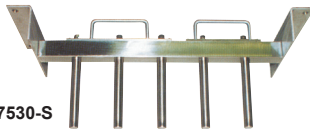

PCMG-A7530-S



PCM2-UD30-S

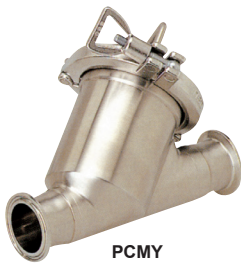

PCMY

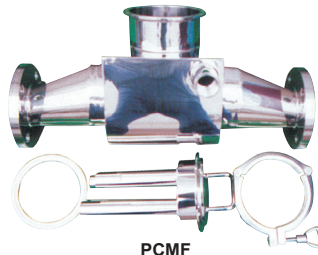

PCMF

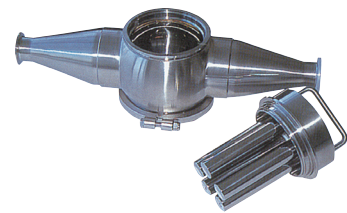

PCMH-T15

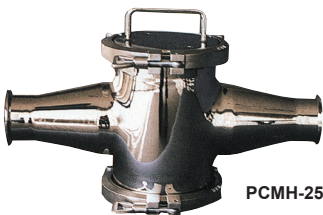

PCMH-25



PCMH-A100-S

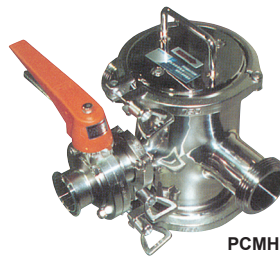

PCMH-T20



PCMH-T15



See an example of flow on page 154.



*Please see the Facsimile Communication Form (Selection Data) on page 178 also.

Other models are also available upon request.

MAGNETIC TOOLS & EQUIPMENT FOR FEEDING OPERATION

LIFTING MAGNET

MAGBOTE[®]

MAGNETIC EQUIPMENT FOR CONVEYANCE

ENVIRONMENTAL EQUIPMENT

MAGNETIZER AND DEMAGNETIZER

MAGNETIC EQUIPMENT FOR CONVEYANCE

MAGNETIC SEPARATORS

POWERFUL MAGNETIC SEPARATORS

MEASURING TOOLS

MEASURING INSTRUMENTS

MAGNETIC MATERIALS

POWERFUL MAGNETIC SEPARATORS

Model PCMB Comparison of sanitary magnetic bars

Type	Model	Surface Max. Magnetic Flux Density	Working Temp. Upper Limit	Remarks
Powerful	PCMB	0.8 Tesla	80°C (176° F)	Standard type.
Fine pitch	PCMB-AM	1.0 Tesla		Pole area increased by 1.5 times. Catch amount and collection rate increased.
Super powerful	PCMB-A PCMB-U	1.2 Tesla		
Semi heat-resistant	PCMB-QT	0.8 Tesla	150°C (302° F)	Low cost type.
Heat-resistant powerful	PCMB-T	0.8 Tesla	240°C (464° F)	Highest working temperature upper limit in this Series.
	PCMB-AT	1.0 Tesla		
Wear resistant	PCMB-J	1.3 Tesla	80°C (176° F)	Highly resistant to wear and corrosion and longer life.
Double-pipe	PCMBD-A	0.8 Tesla		Double-pipe for easy cleaning of attracted iron powder.

*Note that if the separators are used in environment exceeding the working temperature upper limit, the attraction and holding power may drop due to reduction of magnetism.

Model PCMB SANITARY MAGNETIC BAR

[Application]

Suitable for installation as an iron-removing gate in powder materials transfer ducts or liquid passages and tanks. Can be incorporated flexibly to expand a range of applications.

[Features]

- High grade finish of sanitary specification.
- Various lengths are available for a desired combination.
- High power magnetic bars: a powerful rare earth magnet having a property value of 1.2 T (12,000 G) or 1.35 T (13,500 G) or over is incorporated and the surface maximum magnetic flux density is 0.8 T (8,000 G) or 1 T (10,000 G) or over.
- Since a permanent magnet that maintains a strong magnetic force almost perpetually is used, the running cost can be reduced significantly.
- These are of waterproof construction to allow installation in liquid.
- To increase the rate of removal of metallic powder of very weak magnetism, PCMB-U type that has a surface magnetic flux density of 1.2 T (12,000 G) is also available.
- Special sizes are also available.

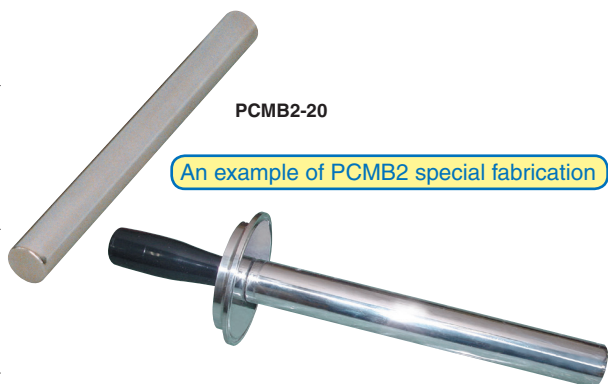

Powerful magnetic bar

Model		Casing Pipe				Built-in Permanent Magnet	Surface Max. Magnetic Flux Density	Working Temp. Upper Limit	Mass
Without tapped hole	With tapped hole	Length	Diameter	Material	Surface finish				
PCMB-10	PCMB2-10	95(3.74)	φ 25*1 (0.98)	SUS304	#400 buffed	Nd rare earth type Property value 1.2T (12,000G)	0.8T (8000G)	80°C (176° F)	0.35kg/0.77 lb
PCMB-15	PCMB2-15	145(5.70)							0.5 kg/1.10 lb
PCMB-20	PCMB2-20	194(7.63)							0.7 kg/1.50 lb
PCMB-25	PCMB2-25	244(9.60)							0.85kg/1.87 lb
PCMB-30	PCMB2-30	295(11.6)							1.05kg/2.31 lb
PCMB-35	PCMB2-35	343(13.5)							1.2 kg/2.64 lb
PCMB-40	PCMB2-40	393(15.4)							1.4 kg/3.08 lb
PCMB-50	PCMB2-50	493(19.4)							1.75kg/3.85 lb
PCMB-60	PCMB2-60	592(23.3)							2.1 kg/4.63 lb

*A casing pipe of SUS316 is also available. *1 A casing pipe of φ 19 is also available.
*For the models with tapped holes, the tapped hole is M6-P1.0 and 7 mm deep, located in the center on each end face. A model of M5, M8, M10 or M12 is also available.

*In order to increase the surface magnetic flux density, the wall thickness of the pipe needs to be decreased. If it is decreased, however, the strength may drop or the pipe may be deformed or broken. Therefore, for the safety reason, pipes of thickness thinner than the current thickness will not be manufactured.

Super powerful magnetic bar

Model		Casing Pipe				Built-in Permanent Magnet	Surface Max. Magnetic Flux Density	Working Temp. Upper Limit	Mass					
Without tapped hole	With tapped hole	Length	Diameter	Material	Surface finish									
PCMB-A15	PCMB2-A15	145(5.70)	φ 25 (0.98)	SUS304	#400 buffed	Nd rare earth type Property value 1.35T (13,500G)	1T (10000G)	80°C (176° F)	0.5 kg/1.10 lb					
PCMB-A20	PCMB2-A20	194(7.63)							0.7 kg/1.54 lb					
PCMB-A25	PCMB2-A25	244(9.60)							0.9 kg/1.98 lb					
PCMB-A30	PCMB2-A30	295(11.6)							1.1 kg/2.42 lb					
PCMB-A35	PCMB2-A35	343(13.5)							1.2 kg/2.64 lb					
PCMB-A40	PCMB2-A40	393(15.4)							1.4 kg/3.08 lb					
PCMB-A50	PCMB2-A50	493(19.4)							1.8 kg/3.96 lb					
PCMB-A60	PCMB2-A60	592(23.3)							2.1 kg/4.63 lb					
PCMB-U10A	PCMB2-U10A	95(3.74)							φ 25.1 (0.99)	SUS316L	#400 buffed	Nd rare earth type Property value 1.38T (13,800G)	1.2T (12000G)	0.3 kg/0.66 lb
PCMB-U15A	PCMB2-U15A	145(5.70)												0.5 kg/1.10 lb
PCMB-U20A	PCMB2-U20A	194(7.63)	0.7 kg/1.50 lb											
PCMB-U25A	PCMB2-U25A	244(9.60)	0.9 kg/1.98 lb											
PCMB-U30A	PCMB2-U30A	295(11.6)	1.1 kg/2.42 lb											
PCMB-U35A	PCMB2-U35A	343(13.5)	1.2 kg/2.64 lb											
PCMB-U40A	PCMB2-U40A	393(15.4)	1.4 kg/3.08 lb											
PCMB-U50A	PCMB2-U50A	493(19.4)	1.8 kg/3.96 lb											
PCMB-U60A	PCMB2-U60A	592(23.3)	2.1 kg/4.63 lb											

*A casing pipe of SUS316 is also available. (Models PCMB-A)
*For the models with tapped holes, the tapped hole is M6-P1.0 and 7 mm deep, located in the center on each end face. A model of M5, M8, M10 or M12 is also available.

*In order to increase the surface magnetic flux density, the wall thickness of the pipe needs to be decreased. If it is decreased, however, the strength may drop or the pipe may be deformed or broken. Therefore, for the safety reason, pipes of thickness thinner than the current thickness will not be manufactured.

Fine pitch powerful magnetic bar

[mm (in)]

Model		Casing Pipe				Built-in Permanent Magnet	Surface Max. Magnetic Flux Density	Working Temp. Upper Limit	Mass
Without tapped hole	With tapped hole	Length	Diameter	Material	Surface finish				
PCMB-AM10	PCMB2-AM10	95 (3.74)	φ25.1 (0.99)	SUS316L	#400 buffed	Nd rare earth type Property value 1.35T (13,500G)	1T (10000G)	80°C (176° F)	0.3kg/0.66 lb
PCMB-AM15	PCMB2-AM15	145 (5.70)							0.5kg/1.10 lb
PCMB-AM20	PCMB2-AM20	194 (7.63)							0.7kg/1.50 lb
PCMB-AM25	PCMB2-AM25	244 (9.60)							0.9kg/1.98 lb
PCMB-AM30	PCMB2-AM30	295 (11.6)							1.1kg/2.42 lb
PCMB-AM35	PCMB2-AM35	343 (13.5)							1.2kg/2.64 lb
PCMB-AM40	PCMB2-AM40	393 (15.4)							1.4kg/3.08 lb
PCMB-AM50	PCMB2-AM50	493 (19.4)							1.8kg/3.96 lb
PCMB-AM60	PCMB2-AM60	592 (23.3)							2.1kg/4.63 lb

※A casing pipe of SUS316 is also available. ※For the models with tapped holes, the tapped hole is M6-P1.0 and 7 mm deep, located in the center on each end face. A model of M5, M8, M10 or M12 is also available. ※In order to increase the surface magnetic flux density, the wall thickness of the pipe needs to be decreased. If it is decreased, however, the strength may drop or the pipe may be deformed or broken. Therefore, for the safety reason, pipes of thickness thinner than the current thickness will not be manufactured.

Semi heat-resistant powerful magnetic bar

[mm (in)]

Model		Casing Pipe				Built-in Permanent Magnet	Surface Max. Magnetic Flux Density	Working Temp. Upper Limit	Mass
Without tapped hole	With tapped hole	Length	Diameter	Material	Surface finish				
PCMB-QT10	PCMB2-QT10	95 (3.74)	φ25 (0.98)	SUS304	#400 buffed	Nd rare earth type Property value 1.1T (11,000G)	0.8T (8000G)	150°C (302° F)	0.35kg/0.77 lb
PCMB-QT15	PCMB2-QT15	145 (5.70)							0.5 kg/1.10 lb
PCMB-QT20	PCMB2-QT20	194 (7.63)							0.7 kg/1.50 lb
PCMB-QT25	PCMB2-QT25	244 (9.60)							0.85kg/1.87 lb
PCMB-QT30	PCMB2-QT30	295 (11.6)							1.05kg/2.31 lb
PCMB-QT35	PCMB2-QT35	343 (13.5)							1.2 kg/2.64 lb
PCMB-QT40	PCMB2-QT40	393 (15.4)							1.4 kg/3.08 lb
PCMB-QT50	PCMB2-QT50	493 (19.4)							1.75kg/3.85 lb
PCMB-QT60	PCMB2-QT60	592 (23.3)							2.1 kg/4.63 lb

※A casing pipe of SUS316 is also available. ※For the models with tapped holes, the tapped hole is M6-P1.0 and 7 mm deep, located in the center on each end face. A model of M5, M8, M10 or M12 is also available. ※In order to increase the surface magnetic flux density, the wall thickness of the pipe needs to be decreased. If it is decreased, however, the strength may drop or the pipe may be deformed or broken. Therefore, for the safety reason, pipes of thickness thinner than the current thickness will not be manufactured.

Heat-resistant powerful magnetic bar

[mm (in)]

Model		Casing Pipe				Built-in Permanent Magnet	Surface Max. Magnetic Flux Density	Working Temp. Upper Limit	Mass
Without tapped hole	With tapped hole	Length	Diameter	Material	Surface finish				
PCMB-T10	PCMB2-T10	95 (3.74)	φ25 (0.98)	SUS304	#400 buffed	Sm rare earth type Property value 1.1T (11,000G)	0.8T (8000G)	240°C (464° F)	0.35kg/0.77 lb
PCMB-T15	PCMB2-T15	145 (5.70)							0.5 kg/1.10 lb
PCMB-T20	PCMB2-T20	194 (7.63)							0.7 kg/1.50 lb
PCMB-T25	PCMB2-T25	244 (9.60)							0.85kg/1.87 lb
PCMB-T30	PCMB2-T30	295 (11.6)							1.05kg/2.31 lb
PCMB-T35	PCMB2-T35	343 (13.5)							1.2 kg/2.64 lb
PCMB-T40	PCMB2-T40	393 (15.4)							1.4 kg/3.08 lb
PCMB-T50	PCMB2-T50	493 (19.4)							1.75kg/3.85 lb
PCMB-T60	PCMB2-T60	592 (23.3)							2.1 kg/4.63 lb

※A casing pipe of SUS316 is also available. ※For the models with tapped holes, the tapped hole is M6-P1.0 and 7 mm deep, located in the center on each end face. A model of M5, M8, M10 or M12 is also available. ※In order to increase the surface magnetic flux density, the wall thickness of the pipe needs to be decreased. If it is decreased, however, the strength may drop or the pipe may be deformed or broken. Therefore, for the safety reason, pipes of thickness thinner than the current thickness will not be manufactured.

Heat-resistant super powerful magnetic bar

[mm (in)]

Model		Casing Pipe				Built-in Permanent Magnet	Surface Max. Magnetic Flux Density	Working Temp. Upper Limit	Mass
Without tapped hole	With tapped hole	Length	Diameter	Material	Surface finish				
PCMB-AT10	PCMB2-AT10	95 (3.74)	φ25.1 (0.99)	SUS316L	#400 buffed	Sm rare earth type Property value 1.2T (12,000G)	1T (10000G)	240°C (464° F)	0.35kg/0.77 lb
PCMB-AT15	PCMB2-AT15	145 (5.70)							0.5 kg/1.10 lb
PCMB-AT20	PCMB2-AT20	194 (7.63)							0.7 kg/1.50 lb
PCMB-AT25	PCMB2-AT25	244 (9.60)							0.85kg/1.87 lb
PCMB-AT30	PCMB2-AT30	295 (11.6)							1.05kg/2.31 lb
PCMB-AT35	PCMB2-AT35	343 (13.5)							1.2 kg/2.64 lb
PCMB-AT40	PCMB2-AT40	393 (15.4)							1.4 kg/3.08 lb
PCMB-AT50	PCMB2-AT50	493 (19.4)							1.75kg/3.85 lb
PCMB-AT60	PCMB2-AT60	592 (23.3)							2.1 kg/4.63 lb

※A casing pipe of SUS316 is also available. ※For the models with tapped holes, the tapped hole is M6-P1.0 and 7 mm deep, located in the center on each end face. A model of M5, M8, M10 or M12 is also available. ※In order to increase the surface magnetic flux density, the wall thickness of the pipe needs to be decreased. If it is decreased, however, the strength may drop or the pipe may be deformed or broken. Therefore, for the safety reason, pipes of thickness thinner than the current thickness will not be manufactured.

Model PCMB-J WEAR-RESISTANT SANITARY MAGNETIC BAR



PCMB2-J20A

An example of incorporation of PCMB-J

Magnetic force exceeding 1.3 Tesla!

[Features]

- The stainless steel surface has been treated by KANETEC's original technology to provide high resistance to wear and corrosion.
- The surface is hardly susceptible to scratches and thus remains polished and glossy, requiring less frequent replacement for economical operations.

[mm (in)]

Model		Casing Pipe				Built-in Permanent Magnet	Surface Max. Magnetic Flux Density	Working Temp. Upper Limit	Mass
Without tapped hole	With tapped hole	Length	Diameter	Material	Surface finish				
PCMB-J10A	PCMB2-J10A	95 (3.74)	φ24.8 (0.97)	SUS316L	#400 buffed + Titanium coating	Nd rare earth type Property value 1.4T (14,000G)	1.3T (13000G)	80°C (176° F)	0.3kg/0.66 lb
PCMB-J15A	PCMB2-J15A	145 (5.70)							0.5kg/1.10 lb
PCMB-J20A	PCMB2-J20A	194 (7.63)							0.7kg/1.50 lb
PCMB-J25A	PCMB2-J25A	244 (9.60)							0.9kg/1.98 lb
PCMB-J30A	PCMB2-J30A	295 (11.6)							1.1kg/2.42 lb
PCMB-J35A	PCMB2-J35A	343 (13.5)							1.2kg/2.64 lb
PCMB-J40A	PCMB2-J40A	393 (15.4)							1.4kg/3.08 lb

※For the models with tapped holes, the tapped hole is M6-P1.0 and 7 mm deep, located in the center on each end face.

MAGNETIC TOOLS & EQUIPMENT
FOR FINE PITCH OPERATION
LIFTING MAGNET
MAGBORE
CHIP & SLUDGE CONVEYANCE EQUIPMENT
ENVIRONMENTAL EQUIPMENT
MAGNETIZER AND DEMAGNETIZER
MAGNETIC EQUIPMENT FOR CONVEYANCE
MAGNETIC SEPARATORS
POWERFUL MAGNETIC SEPARATORS
MEASURING TOOLS
MEASURING INSTRUMENTS
MAGNETIC MATERIALS

POWERFUL MAGNETIC SEPARATORS PCMBD-A / PCMB-S / PCMB-K

Model PCMBD-A SUPER POWERFUL MAGNETIC BAR (DOUBLE-PIPE)

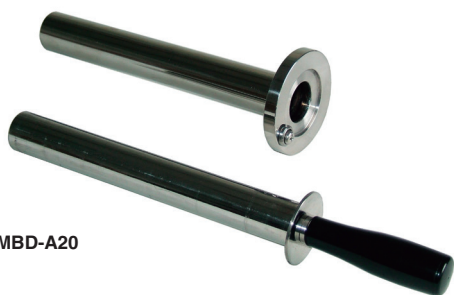

PCMBD-A20

[Application]

Most suitable for cleaning places where a relatively large amount of iron powder, etc. is mixed.

[Features]

- Since these bars are of double-pipe type, attracted iron powder smoothly drops when the magnetic bar is pulled out.
- The outer pipe and the magnetic bar have a flange. When the magnetic bar is housed, the two flanges become one piece to prevent intrusion of foreign matter to the inside of the magnetic bar and to prevent the magnetic bar from coming out.
- The magnetic bar has an easy-to-hold plastic grip.

Model	Surface Material	Surface Finish	Surface Max. Magnetic Flux Density	Working Temp. Upper Limit	Dimensions				Mass
					L	ℓ	G	D	
PCMBD-A13	SUS 304	#400 buffed	0.8 T (8000 G) min.	80°C (176°F)	216 (8.50)	125 (4.92)	83 (3.26)	24 (0.94)	0.8kg/1.7 lb
PCMBD-A20					285 (11.2)	194 (7.63)			1.1kg/2.4 lb
PCMBD-A25					352 (13.8)	244 (9.60)	100 (3.93)	28 (1.10)	1.3kg/2.8 lb
PCMBD-A30					403 (15.8)	295 (11.6)	100 (3.93)	28 (1.10)	1.5kg/3.3 lb

[mm (in)]

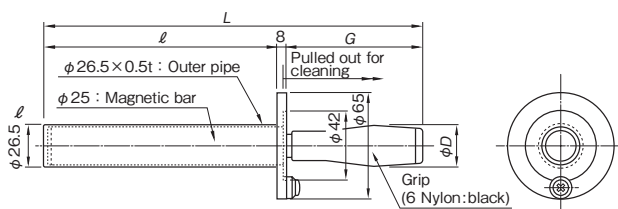

*A type having a surface maximum magnetic flux density of 0.95 T (9500 G) is also available. (Optional)

Model PCMB-S SANITARY MAGNETIC BAR WITH STAND

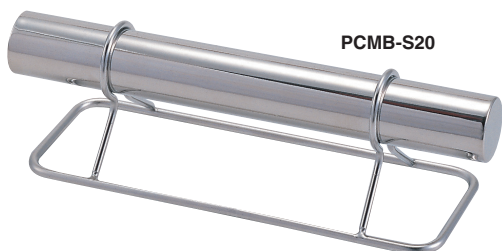

PCMB-S20

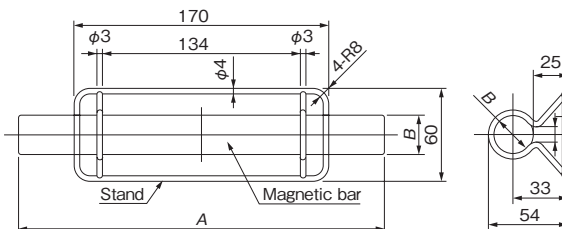

[Features]

The sanitary magnetic bar (PCMB) is provided with a stand. Can be installed in a liquid tank for collection and removal of iron particles.

Powerful type

Model	Dimensions		Material	Surface Finish		Built-in Permanent Magnet	Surface Max. Magnetic Flux Density	Working Temp. Upper Limit	Mass
	A	B		Magnetic bar	Stand				
PCMB-S20	194 (7.63)	φ25 (0.98)	SUS304	#400 buffed	Electrolytic polishing	Nd rare earth type Property value 1.2 T (12,000 G)	0.8T (8000G)	80°C (176°F)	0.6kg/1.32 lb
PCMB-S25	244 (9.60)								0.65kg/1.43 lb
PCMB-S30	295 (11.6)								0.7kg/1.50 lb

Heat-resistant powerful type

Model	Dimensions		Material	Surface Finish		Built-in Permanent Magnet	Surface Max. Magnetic Flux Density	Working Temp. Upper Limit	Mass
	A	B		Magnetic bar	Stand				
PCMB-TS20	194 (7.63)	φ25 (0.98)	SUS304	#400 buffed	Electrolytic polishing	Sm rare earth type Property value 1.1 T (11,000 G)	0.8T (8000G)	240°C (464°F)	0.6kg/1.32 lb
PCMB-TS25	244 (9.60)								0.65kg/1.43 lb
PCMB-TS30	295 (11.6)								0.7kg/1.50 lb

Super powerful type

Model	Dimensions		Material	Surface Finish		Built-in Permanent Magnet	Surface Max. Magnetic Flux Density	Working Temp. Upper Limit	Mass
	A	B		Magnetic bar	Stand				
PCMB-AS20	194 (7.63)	φ25 (0.98)	SUS304	#400 buffed	Electrolytic polishing	Nd rare earth type Property value 1.35 T (13,500 G)	1T (10000G)	80°C (176°F)	0.6kg/1.32 lb
PCMB-AS25	244 (9.60)								0.65kg/1.43 lb
PCMB-AS30	295 (11.6)								0.7kg/1.50 lb

Model PCMB-K CLEANER TO REMOVE IRON POWDER ON MAGNETIC BAR

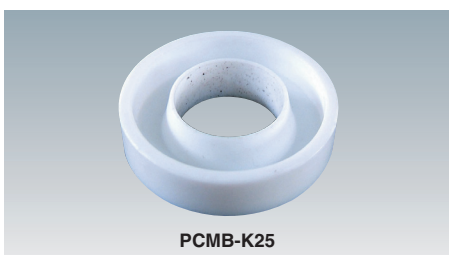

PCMB-K25

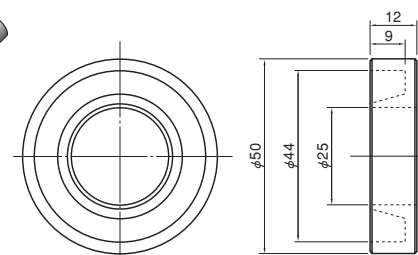
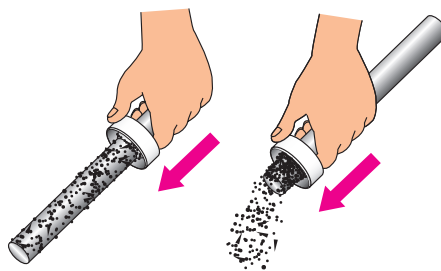

[Application]

A cleaner to remove iron powder on a sanitary magnetic bar.

[Features]

- A groove is provided to receive iron powder so that it does not scatter.
- When this is installed on each end of a sanitary magnetic bar, they serve as a stand also.

Model	Casing (Material)	Applicable Magnetic Bar Dia.
PCMB-K25	Teflon	φ25 (0.98)

POWERFUL MAGNETIC SEPARATORS

An example of flow of removing magnetized foreign matter

See the examples of fabrication on pages 149 and 150 also.

Rectangular grid type magnetic bar unit

Model **PCMG**
P155

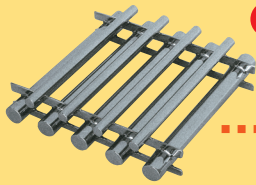

Beverages Juice, coffee, dairy products, tea
Seasoning powder Red pepper, powder wasabi, flavored rice sprinkles
Seasoning liquid Miso, soy source, soup
Candy raw materials/Medicine/Chemicals/Glass

Round grid type magnetic bar unit

Model **PCMG-C**
P156



Magnetic pipe
Model **PCMP**
P159

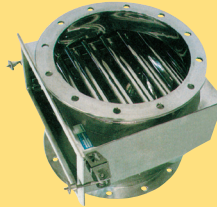

Seasoning powder Red pepper, powder wasabi, flavored rice sprinkles
Medicine/Cosmetics/Plastic pellets

Magnetic filter
P157-158 Model **PCMH2**



Beverages Juice, coffee, dairy products, tea
Seasoning liquid Miso, soy source, soup

L-type magnetic filter

Model **PCML**
P160

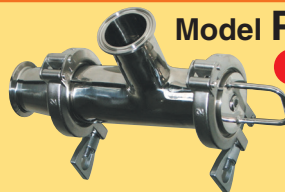

Beverages Juice, coffee, dairy products, tea
Seasoning liquid Miso, soy source, soup

Straight type magnetic filter
Model **PCMS**

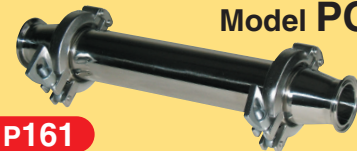

P161
Beverages Juice, coffee, dairy products, tea
Seasoning liquid Miso, soy source, soup

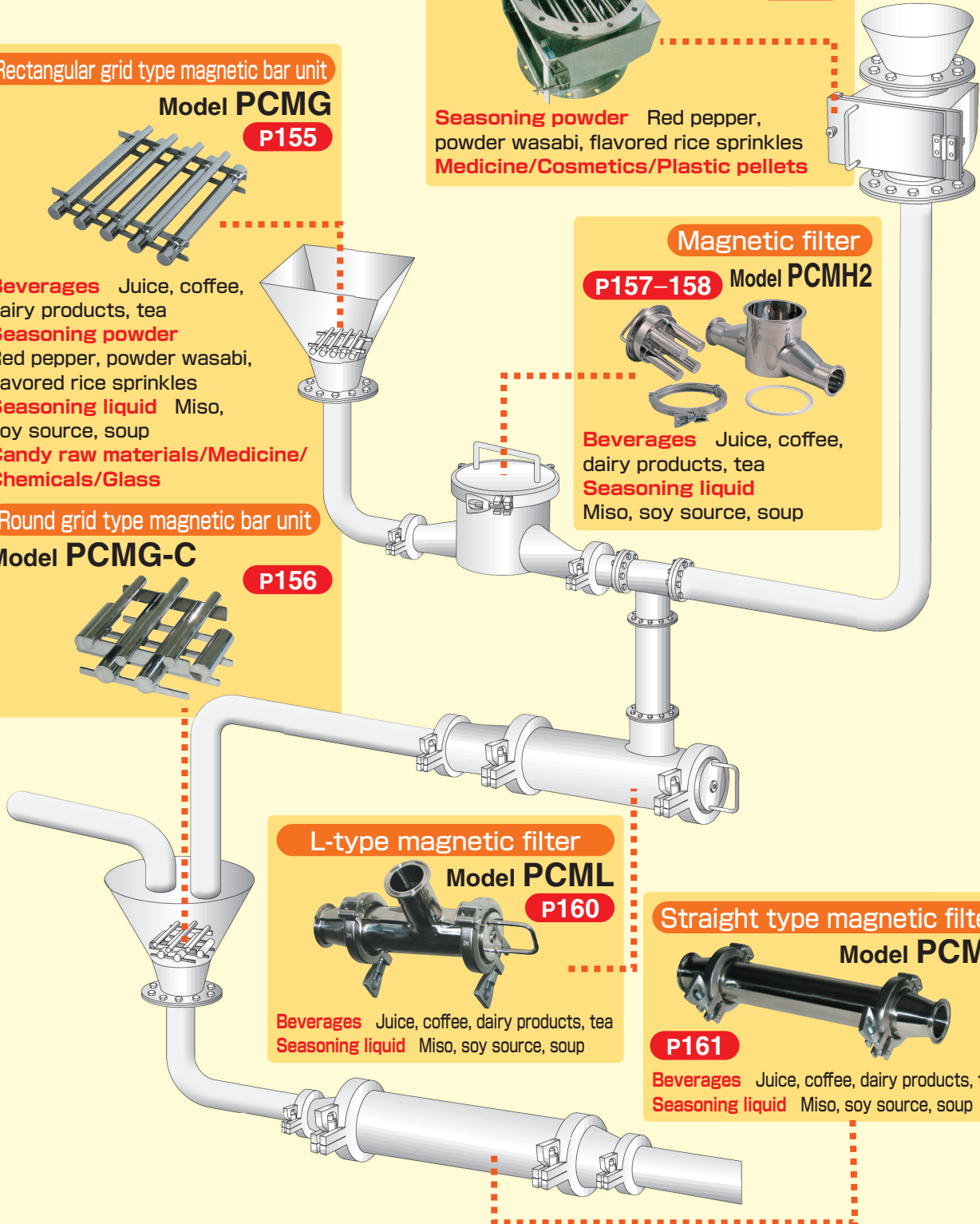

MAGNETIC TOOLS & EQUIPMENT
FOR FEEDING OPERATION

LIFTING
MAGNET

MAGBORE*

CHIP & SLUDGE
CONVEYANCE EQUIPMENT

ENVIRONMENTAL
EQUIPMENT

MAGNETIZER AND
DEMAGNETIZER

MAGNETIC EQUIPMENT
FOR CONVEYANCE

MAGNETIC
SEPARATORS

POWERFUL MAGNETIC
SEPARATORS

MEASURING
TOOLS

MEASURING
INSTRUMENTS

MAGNETIC
MATERIALS

POWERFUL MAGNETIC SEPARATORS

Model PCMG POWERFUL RECTANGULAR GRID TYPE MAGNETIC BAR UNIT

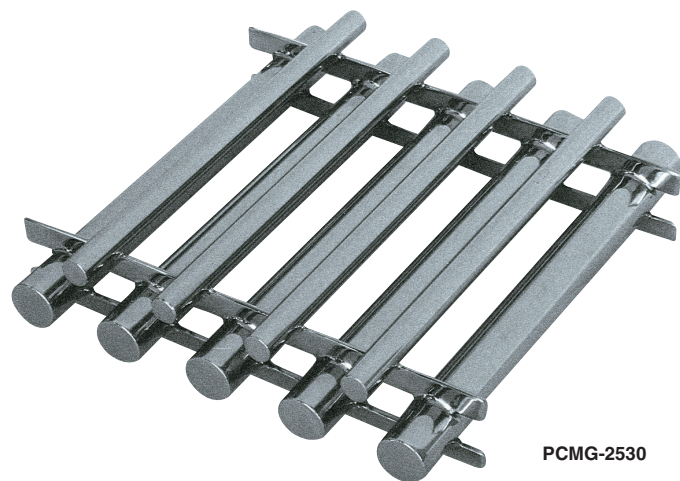

PCMG-2530

[Application]

A unit consisting of powerful magnetic bars arranged in a grid. It is used to remove iron from various granular materials when they fall in rectangular ducts. It can also be placed or suspended in a liquid tank to remove iron.

[Features]

- High grade finish of sanitary specification.
- Various sizes are available to meet various duct sizes.
- High power magnetic bars: a powerful rare earth magnet having a property value of 1.2 T (12,000 G) or 1.35 T (13,500 G) or over is incorporated and the surface maximum magnetic flux density is 0.8 T (8,000 G) or 1 T (10,000 G) or over.
- Since permanent magnets that maintain a strong magnetic force almost perpetually are used, the running cost can be reduced significantly.
- These are of waterproof construction to allow installation in liquid.

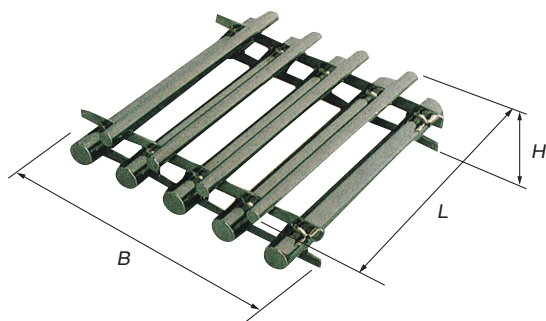

Magnets in action behind delicious bread and sense of security.

Powerful rectangular grid type magnetic bar unit

[mm (in)]

Model	Processing Capacity	Dimensions			Applicable Magnetic Bar			Casing		Surface Max. Magnetic Flux Density	Working Temp. Upper Limit	Mass	Remarks
		B	L	H	Dia.	Magnet used	Qty	Material	Finish				
PCMG-2020	6m³/h	194 (7.63)	194 (7.63)	65 (2.55)	φ25 (0.98)	Nd rare earth type Property value 1.2 T (12,000 G)	4	SUS304	#400 buffed	0.8T (8000G)	80°C (176° F)	3 kg/ 6.6 lb	SUS316 version also available.
PCMG-2025	8m³/h		244 (9.60)									3.6kg/ 7.9 lb	
PCMG-2525	10m³/h	244 (9.60)	4.5kg/ 9.9 lb										
PCMG-2530	12m³/h		5.4kg/11.9 lb										
PCMG-3030	14m³/h	295 (11.6)	6.5kg/14.3 lb										
PCMG-3040	18m³/h		8.2kg/18.1 lb										
PCMG-4040	24m³/h	393 (15.4)	12 kg/26.4 lb										

※A 2-stage type or a type with frame is also available upon request.

Heat-resistant powerful rectangular grid type magnetic bar unit

[mm (in)]

Model	Processing Capacity	Dimensions			Applicable Magnetic Bar			Casing		Surface Max. Magnetic Flux Density	Working Temp. Upper Limit	Mass	Remarks
		B	L	H	Dia.	Magnet used	Qty	Material	Finish				
PCMG-T2020	6m³/h	194 (7.63)	194 (7.63)	65 (2.55)	φ25 (0.98)	Sm rare earth type Property value 1.1 T (11,000 G)	4	SUS304	#400 buffed	0.8T (8000G)	240°C (464° F)	3 kg/ 6.6 lb	SUS316 version also available.
PCMG-T2025	8m³/h		244 (9.60)									3.6kg/ 7.9 lb	
PCMG-T2525	10m³/h	244 (9.60)	4.5kg/ 9.9 lb										
PCMG-T2530	12m³/h		5.4kg/11.9 lb										
PCMG-T3030	14m³/h	295 (11.6)	6.5kg/14.3 lb										
PCMG-T3040	18m³/h		8.2kg/18.1 lb										
PCMG-T4040	24m³/h	393 (15.4)	12 kg/26.4 lb										

※A 2-stage type or a type with frame is also available upon request.

Super powerful rectangular grid type magnetic bar unit

[mm (in)]

Model	Processing Capacity	Dimensions			Applicable Magnetic Bar			Casing		Surface Max. Magnetic Flux Density	Working Temp. Upper Limit	Mass	Remarks
		B	L	H	Dia.	Magnet used	Qty	Material	Finish				
PCMG-A2020	6m³/h	194 (7.63)	194 (7.63)	65 (2.55)	φ25 (0.98)	Nd rare earth type Property value 1.35 T (13,500 G)	4	SUS304	#400 buffed	1T (10000G)	80°C (176° F)	3 kg/ 6.6 lb	SUS316 version also available.
PCMG-A2025	8m³/h		244 (9.60)									3.6kg/ 7.9 lb	
PCMG-A2525	10m³/h	244 (9.60)	4.5kg/ 9.9 lb										
PCMG-A2530	12m³/h		5.4kg/11.9 lb										
PCMG-A3030	14m³/h	295 (11.6)	6.5kg/14.3 lb										
PCMG-A3040	18m³/h		8.2kg/18.1 lb										
PCMG-A4040	24m³/h	393 (15.4)	12 kg/26.4 lb										

※A 2-stage type or a type with frame is also available upon request.

MAGNETIC TOOL & EQUIPMENT FOR MINING OPERATION
 LIFTING MAGNET
 MAGBORE*
 OHP & SLUDGE CONVEYANCE EQUIPMENT
 ENVIRONMENTAL MAGNETIZER AND DEMAGNETIZER EQUIPMENT
 MAGNETIC EQUIPMENT FOR CONVEYANCE
 MAGNETIC SEPARATORS
 POWERFUL MAGNETIC SEPARATORS
 MEASURING TOOLS
 MEASURING INSTRUMENTS
 MAGNETIC MATERIALS

Model PCMG-C POWERFUL ROUND GRID TYPE MAGNETIC BAR UNIT



PCMG-C20

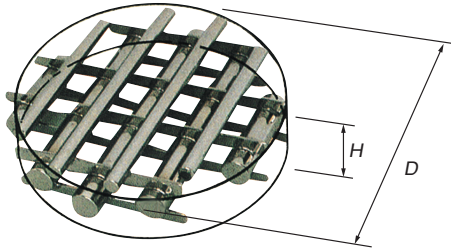

[Application]

A unit consisting of powerful magnetic bars arranged in a grid. It is used to remove iron from various granular materials when they fall in round ducts or pipes. It can also be placed or suspended in a liquid tank to remove iron.

[Features]

- High grade finish of sanitary specification.
- Various sizes are available to meet various duct sizes and pipe diameters.
- High power magnetic bars: a powerful rare earth magnet having a property value of 1.2 T (12,000 G) or 1.35 T (13,500 G) or over is incorporated and the surface maximum magnetic flux density is 0.8 T (8,000 G) or 1 T (10,000 G) or over.
- These are of waterproof construction to allow installation in liquid.
- Since permanent magnets that maintain a strong magnetic force almost perpetually are used, the running cost can be reduced significantly.



Magnets contributing to the glitter of pure white crystal sugar.

An example of equipment utilizing magnetic bars

This equipment can turn its magnetic force on and off to remove attracted iron. When the lever is pulled, the magnetic bars in the pipes move to the box and the pipes lose the magnetic force. When the lever is pushed in, the pipes regain the magnetic force.

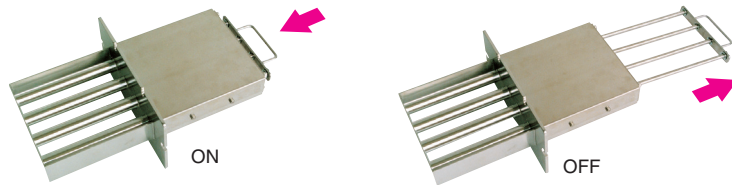

※ This equipment is made to order and will be manufactured after determination of sizes, etc. with the customer.

Powerful round grid type magnetic bar unit

[mm (in)]

Model	Processing Capacity	Dimensions		Applicable Magnetic Bar			Casing		Surface Max. Magnetic Flux Density	Working Temp. Upper Limit	Mass	Remarks
		D	H	Dia.	Magnet used	Qty	Material	Finish				
PCMG-C20	4.5m ³ /h	φ 196 (7.71)	65 (2.55)	φ 25 (0.98)	Nd rare earth type Property value 1.2 T (12,000 G)	4	SUS304	#400 buffed	0.8T (8000G)	80°C (176° F)	2.2kg/ 4.8 lb	SUS316 version also available.
PCMG-C25	7 m ³ /h	φ 246 (9.68)				5					3.6kg/ 7.9 lb	
PCMG-C30	10 m ³ /h	φ 296 (11.6)				6					5 kg/11.0 lb	
PCMG-C35	13 m ³ /h	φ 346 (13.6)				7					6.5kg/14.3 lb	
PCMG-C40	17 m ³ /h	φ 396 (15.5)				8					7.8kg/17.2 lb	

※ A 2-stage type or a type with frame is also available upon request.

Heat-resistant powerful round grid type magnetic bar unit

[mm (in)]

Model	Processing Capacity	Dimensions		Applicable Magnetic Bar			Casing		Surface Max. Magnetic Flux Density	Working Temp. Upper Limit	Mass	Remarks
		D	H	Dia.	Magnet used	Qty	Material	Finish				
PCMG-TC20	4.5m ³ /h	φ 196 (7.71)	65 (2.55)	φ 25 (0.98)	Sm rare earth type Property value 1.1 T (11,000 G)	4	SUS304	#400 buffed	0.8T (8000G)	240°C (464° F)	2.2kg/ 4.8 lb	SUS316 version also available.
PCMG-TC25	7 m ³ /h	φ 246 (9.68)				5					3.6kg/ 7.9 lb	
PCMG-TC30	10 m ³ /h	φ 296 (11.6)				6					5 kg/11.0 lb	
PCMG-TC35	13 m ³ /h	φ 346 (13.6)				7					6.5kg/14.3 lb	
PCMG-TC40	17 m ³ /h	φ 396 (15.5)				8					7.8kg/17.2 lb	

※ A 2-stage type or a type with frame is also available upon request.

Super powerful round grid type magnetic bar unit

[mm (in)]

Model	Processing Capacity	Dimensions		Applicable Magnetic Bar			Casing		Surface Max. Magnetic Flux Density	Working Temp. Upper Limit	Mass	Remarks
		D	H	Dia.	Magnet used	Qty	Material	Finish				
PCMG-AC20	4.5m ³ /h	φ 196 (7.71)	65 (2.55)	φ 25 (0.98)	Nd rare earth type Property value 1.35 T (13,500 G)	4	SUS304	#400 buffed	1T (10000G)	80°C (176° F)	2.2kg/ 4.8 lb	SUS316 version also available.
PCMG-AC25	7 m ³ /h	φ 246 (9.68)				5					3.6kg/ 7.9 lb	
PCMG-AC30	10 m ³ /h	φ 296 (11.6)				6					5 kg/11.0 lb	
PCMG-AC35	13 m ³ /h	φ 346 (13.6)				7					6.5kg/14.3 lb	
PCMG-AC40	17 m ³ /h	φ 396 (15.5)				8					7.8kg/17.2 lb	

※ A 2-stage type or a type with frame is also available upon request.

MAGNETIC TOOLS & EQUIPMENT FOR FEEDING OPERATION
LIFTING MAGNET
MAGBORE
CHIP & SLUDGE CONVEYANCE EQUIPMENT
ENVIRONMENTAL EQUIPMENT
MAGNETIZER AND DEMAGNETIZER
MAGNETIC EQUIPMENT FOR CONVEYANCE
MAGNETIC SEPARATORS
POWERFUL MAGNETIC SEPARATORS
MEASURING TOOLS
MEASURING INSTRUMENTS
MAGNETIC MATERIALS

POWERFUL MAGNETIC SEPARATORS

Model **PCMH** MAGNETIC FILTER FOR VISCOUS LIQUID

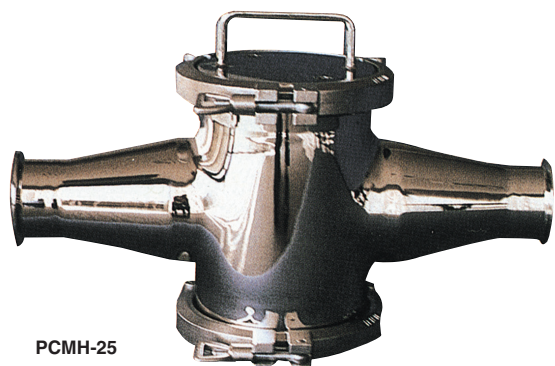

PCMH-25

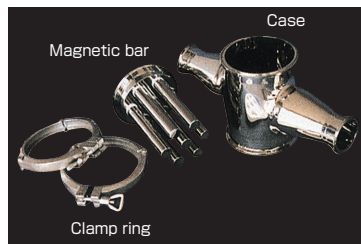

[Application]

This filter is recommended for installation between manufacturing processes in plants of viscous foods like pasty juice and chemical products like viscous cosmetic liquids to separate and catch harmful magnetic fine particles.

[Features]

- High grade finish of sanitary specification.
- Can withstand high pressure and high viscosity.
- Various sizes are available to meet various pipe diameters.
- Since permanent magnets that maintain a strong magnetic force almost perpetually are used, the running cost can be reduced significantly.
- Powerful magnetic bars having a surface magnetic flux density of 0.8 T or 1 T or over are built in, that shows superb performance in collecting iron from flowing fluids.
- A heat-resistant powerful version that can maintain its strong magnetic force without significant deterioration when used continuously in fluids up to 150°C is also available.

<PCMH Series>

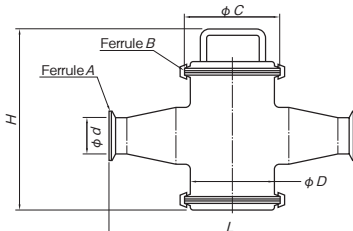

<PCMH2 Series>

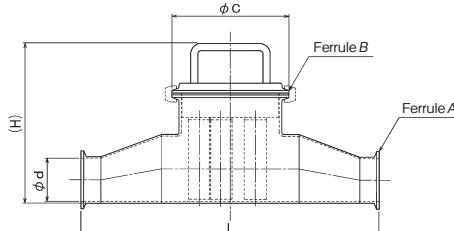

Powerful type / Heat-resistant powerful type

[mm (in)]

Model		Material	Finish	Pressure Resistance Limit	Viscosity Upper Limit of Applicable Fluid (Ref)	Magnetic Bar		Dimensions						Working Temp. Upper Limit	Mass					
Powerful	Heat-resistant powerful					Material	Qty	Surface max. magnetic flux density	A	d	B	C	D			L	H			
PCMH -15	PCMH -T15	SUS 304	#400 buffed	1,000kPa (10kgf/cm ²)	1 × 10 ⁶ mPa·s (1 × 10 ⁵ cP)	SUS 304	5	0.8T (8000G)	1 1/2S	35.7 (1.41)	4 1/2S	130	114.3 (4.50)	330 (12.9)	240 (9.44)	Powerful type 80°C (176° F) Heat-resistant powerful type 150°C (302° F)	10.2kg/22.5 lb	11.5kg/25.0 lb		
PCMH -20	PCMH -T20								2 S	47.8 (1.88)										
PCMH -25	PCMH -T25								2 1/2S	59.5 (2.34)	5 1/2S	155 (6.10)	139.8 (5.50)	420 (16.5)	260 (10.2)		6.5kg/14.3 lb			
PCMH -30	PCMH -T30								3 S	72.3 (2.84)										
PCMH -35	PCMH -T35								3 1/2S	85.1 (3.35)										
PCMH2-15	PCMH2-T15								SUS 304	#400 buffed	500kPa (5kgf/cm ²)	1.5 × 10 ⁶ mPa·s (1.5 × 10 ⁴ cP)	SUS 304	5	1T (10000G)			1 1/2S	35.7 (1.41)	4 1/2S
PCMH2-20	PCMH2-T20			2 S	47.8 (1.88)															
PCMH2-25	PCMH2-T25			2 1/2S	59.5 (2.34)	5 1/2S	155 (6.10)	-										420 (16.5)	203 (7.99)	
PCMH2-30	PCMH2-T30			3 S	72.3 (2.84)															
PCMH2-35	PCMH2-T35			3 1/2S	85.1 (3.35)															

*A SUS316 version is also available upon request. The standard connection method is by use of ferrules, but a screw type or flange type is also available.

Super powerful type / Heat-resistant super powerful type

[mm (in)]

Model		Material	Finish	Pressure Resistance Limit	Viscosity Upper Limit of Applicable Fluid (Ref)	Magnetic Bar		Dimensions						Working Temp. Upper Limit	Mass					
Powerful	Heat-resistant powerful					Material	Qty	Surface max. magnetic flux density	A	d	B	C	D			L	H			
PCMH -A15	PCMH -AT15	SUS 304	#400 buffed	1,000kPa (10kgf/cm ²)	1 × 10 ⁶ mPa·s (1 × 10 ⁵ cP)	SUS 304	5	1T (10000G)	1 1/2S	35.7 (1.41)	4 1/2S	130	114.3 (4.50)	330 (12.9)	240 (9.44)	Super powerful type 80°C (176° F) Heat-resistant super powerful type 150°C (302° F)	10.2kg/22.5 lb	11.5kg/25.0 lb		
PCMH -A20	PCMH -AT20								2 S	47.8 (1.88)										
PCMH -A25	PCMH -AT25								2 1/2S	59.5 (2.34)	5 1/2S	155 (6.10)	139.8 (5.50)	420 (16.5)	260 (10.2)		6.5kg/14.3 lb			
PCMH -A30	PCMH -AT30								3 S	72.3 (2.84)										
PCMH -A35	PCMH -AT35								3 1/2S	85.1 (3.35)										
PCMH2-A15	PCMH2-AT15								SUS 304	#400 buffed	500kPa (5kgf/cm ²)	1.5 × 10 ⁶ mPa·s (1.5 × 10 ⁴ cP)	SUS 304	5	1T (10000G)			1 1/2S	35.7 (1.41)	4 1/2S
PCMH2-A20	PCMH2-AT20			2 S	47.8 (1.88)															
PCMH2-A25	PCMH2-AT25			2 1/2S	59.5 (2.34)	5 1/2S	155 (6.10)	-										420 (16.5)	203 (7.99)	
PCMH2-A30	PCMH2-AT30			3 S	72.3 (2.84)															
PCMH2-A35	PCMH2-AT35			3 1/2S	85.1 (3.35)															

*A SUS316 version is also available upon request. The standard connection method is by use of ferrules, but a screw type or flange type is also available.

Model **PCMH2-E** MAGNETIC FILTER FOR VISCOUS LIQUID



PCMH2-E20

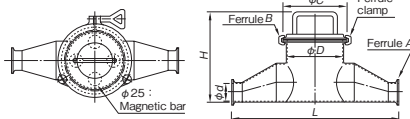

[Application]

Since these filters have been made by welding all around, they are suitable for food processing operations; in particular, most suitable for operations where the growth of bacteria is never allowed.

[Features]

- The magnetic bar imbedded part has been welded all around and buffed for clean operations.
- A super powerful type and heat-resistant type are also available.

[mm (in)]

Model	Material	Finish	Pressure Resistance Limit	Viscosity Upper Limit of Applicable Fluid (Ref)	Material	Qty	Surface max. magnetic flux density	A	d	B	C	D	L	H	Working Temp. Upper Limit	Mass
PCMH2-E15	SUS 304	#400 buffed	500kPa (5kgf/cm ²)	1.5 × 10 ⁶ mPa·s (1.5 × 10 ⁴ cP)	SUS 304	4	0.8T (8000G)	1 1/2S	35.7 (1.41)	4 1/2S	130	114.3 (4.50)	330 (12.9)	177 (6.96)	80°C (176° F)	6.5kg/14.3 lb
PCMH2-E20								2 S	47.8 (1.88)							
PCMH2-E25								2 1/2S	59.5 (2.34)	5 1/2S	155 (6.10)	139.8 (5.50)	420 (16.5)	203 (7.99)		
PCMH2-E30								3 S	72.3 (2.84)							
PCMH2-E35								3 1/2S	85.1 (3.35)							

*A SUS316 version is also available upon request. The standard connection method is by use of ferrules, but a screw type or flange type is also available.

MAGNETIC TOOLS & EQUIPMENT
 FOR FOODS & CHEMICALS OPERATION
 LIFTING MAGNET
 MAGBORE*
 OHP & SLIDE
 CONVENIENCE EQUIPMENT
 ENVIRONMENTAL
 MAGNETIZER AND
 DEMAGNETIZER
 FOR CONVENIENCE
 MAGNETIC EQUIPMENT
 SEPARATORS
 POWERFUL MAGNETIC
 SEPARATORS
 MEASURING TOOLS
 MEASURING INSTRUMENTS
 MATERIALS

Model PCMH2-D-A/TD-A MAGNETIC FILTER FOR VISCOUS AND HEAT-RESISTANT LIQUID

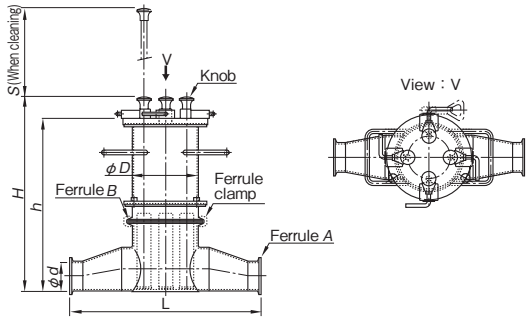

[Application]

Since these filters have been made by welding all around, they are suitable for food processing operations; in particular, most suitable for operations where the growth of bacteria is never allowed. The filter can be locked with the magnets turned off and therefore these filters are suitable for lines where they are to be cleaned without removing the magnet part.

[Features]

- Manual ON/OFF switching is possible. (Inserting and removing each magnetic bar makes the ON/OFF operation lighter.)
- The fixing part of the outer pipe that comes in contact with liquid has been welded all around and buffed smoothly, which prevents accumulation of liquid to ensure clean operation.
- A special version having 6 magnetic bars is also available.
- The working temperature up to 150°C is allowed. (TD-A type)
- A super powerful magnetic filter is also available.

Model	Material	Finish	Pressure Resistance Limit	Viscosity Upper Limit of Applicable Fluid (Ref)	Magnetic Bar			Dimensions								Working Temp. Upper Limit	Mass			
					Material	Qty	Surface max. magnetic flux density	A	d	B	D	L	H	S	h					
PCMH2-D15A	SUS 304	#400 buffed	500kPa (5kgf/cm ²)	1.5 × 10 ⁴ mPa·s (1.5 × 10 ⁴ cP)	SUS 304	0.8T (8000G)	1 1/2 S	35.7 (1.41)	4 1/2 S	114 (4.48)	330 (12.9)	336 (13.2)	153 (6.02)	299 (11.7)	80°C (176° F)	13kg/28.6 lb				
2 S							47.8 (1.88)	140 (5.51)		420 (16.5)	484 (19.0)	179 (7.04)	347 (13.6)							
2 1/2 S							59.5 (2.34)	5 1/2 S	140 (5.51)	420 (16.5)	484 (19.0)	179 (7.04)	347 (13.6)	15kg/33.0 lb						
3 S							72.3 (2.84)		1 1/2 S	35.7 (1.41)	4 1/2 S	114 (4.48)	330 (12.9)				336 (13.2)	153 (6.02)	299 (11.7)	
3 1/2 S							85.1 (3.35)		2 S	47.8 (1.88)		140 (5.51)	420 (16.5)				484 (19.0)	179 (7.04)	347 (13.6)	
2 1/2 S							59.5 (2.34)	5	1 1/2 S	35.7 (1.41)	4 1/2 S	114 (4.48)	330 (12.9)			336 (13.2)	153 (6.02)	299 (11.7)	150°C (302° F)	13kg/28.6 lb
3 S							72.3 (2.84)		2 S	47.8 (1.88)		140 (5.51)	420 (16.5)			484 (19.0)	179 (7.04)	347 (13.6)		
3 1/2 S							85.1 (3.35)	4	2 1/2 S	59.5 (2.34)	5 1/2 S	140 (5.51)	420 (16.5)	484 (19.0)		179 (7.04)	347 (13.6)	15kg/33.0 lb		
PCMH2-TD15A							1 1/2 S		35.7 (1.41)	4 1/2 S		114 (4.48)	330 (12.9)	336 (13.2)		153 (6.02)	299 (11.7)			
PCMH2-TD20A							2 S	47.8 (1.88)	5		2 1/2 S	59.5 (2.34)	5 1/2 S	140 (5.51)		420 (16.5)	484 (19.0)			
PCMH2-TD25A	3 S	72.3 (2.84)	4	3 S	72.3 (2.84)	5 1/2 S	140 (5.51)	420 (16.5)		484 (19.0)	179 (7.04)	347 (13.6)								
PCMH2-TD30A	3 1/2 S	85.1 (3.35)		5	3 1/2 S		85.1 (3.35)	5 1/2 S	140 (5.51)	420 (16.5)	484 (19.0)	179 (7.04)	347 (13.6)							
PCMH2-TD35A																				

*A SUS316 version is also available upon request. The standard connection method is by use of ferrules, but a screw type or flange type is also available.
 *A type having a surface maximum magnetic flux density of 0.95 T (9500 G) is also available. (Optional)

Model PCMH2-D-B MAGNETIC FILTER FOR VISCOUS LIQUID

Safe and easy cleaning to enhance the work efficiency!

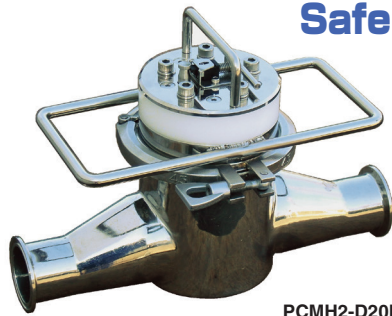

PCMH2-D20B

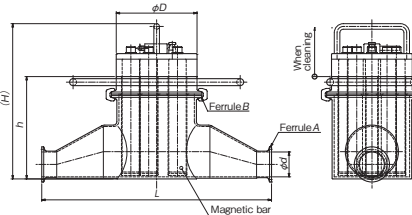

[Application]

This filter is recommended for installation in a passage between manufacturing processes in plants of pasty viscous foods like juice and chemical products to separate and catch magnetic fine particles.

[Features]

- The outer pipe that comes in contact with liquid and the magnetic bar unit can be pulled out together, which improves the workability and facilitates cleaning.
- The filter is of simple construction to facilitate replacement of parts and checking of magnetic bars.
- A dedicated magnetic bar housing case is available optionally. A case to house a desired number of bars is also available.

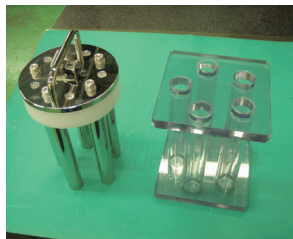

Model	Material	Finish	Pressure Resistance Limit	Viscosity Upper Limit of Applicable Fluid (Ref)	Magnetic Bar			Dimensions								Working Temp. Upper Limit	Mass
					Material	Qty	Surface max. magnetic flux density	A	d	B	D	L	H	h			
PCMH2-D15B	SUS 304	#400 buffed	500kPa (5kgf/cm ²)	1.5 × 10 ⁴ mPa·s (1.5 × 10 ⁴ cP)	SUS 304	0.8T (8000G)	1 1/2 S	35.7 (1.41)	4 1/2 S	116 (4.56)	330 (12.9)	223 (8.77)	147 (5.78)	80°C (176° F)	8kg/17.6 lb		
2 S							47.8 (1.88)	140 (5.51)		420 (16.5)	261 (10.2)	178 (7.00)					
2 1/2 S							59.5 (2.34)	5 1/2 S	140 (5.51)	420 (16.5)	261 (10.2)	178 (7.00)					
3 S							72.3 (2.84)		1 1/2 S	35.7 (1.41)	4 1/2 S	116 (4.56)	330 (12.9)			223 (8.77)	147 (5.78)
3 1/2 S							85.1 (3.35)		2 S	47.8 (1.88)		140 (5.51)	420 (16.5)			261 (10.2)	178 (7.00)
PCMH2-D20B	2 S	47.8 (1.88)	6	2 1/2 S	59.5 (2.34)	5 1/2 S	140 (5.51)	420 (16.5)	261 (10.2)	178 (7.00)							
PCMH2-D25B	3 S	72.3 (2.84)		3 S	72.3 (2.84)		5 1/2 S	140 (5.51)	420 (16.5)	261 (10.2)	178 (7.00)						
PCMH2-D30B	3 1/2 S	85.1 (3.35)	3 1/2 S	85.1 (3.35)	5 1/2 S	140 (5.51)		420 (16.5)	261 (10.2)	178 (7.00)							
PCMH2-D35B																	

Model PCMH4 MAGNETIC FILTER FOR VISCOUS LIQUID



PCMH4-25

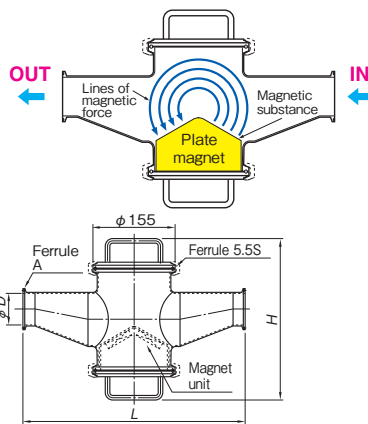

[Application]

Most suitable for collecting magnetic substances and weak magnetic substances in manufacturing lines of viscous liquid foods and chemical products containing solids.

[Features]

- These filters have been so constructed as to ensure smooth flow of materials to process and cause the magnetic force to act up to the top of the casing, ensuring efficient collection of magnetic substances.
- Easy overhaul and reliable cleaning.
- No liquid remains, ensuring clean operations.

Model	Surface Max. Magnetic Flux Density	Pressure Resistance Limit	Dimensions				Mass
			L	H	A	φD	
PCMH4-15	0.35T (3500G)	500kPa (5kgf/cm ²)	360 (14.1)	304 (11.9)	1.5S	35.7 (1.41)	12.8kg/28.2 lb
PCMH4-20			2 S		47.8 (1.88)	13.8kg/30.4 lb	
PCMH4-25			2.5S	59.5 (2.34)	15 kg/33.0 lb		
PCMH4-30			3 S	72.3 (2.84)	16.3kg/35.9 lb		
PCMH4-35			3.5S	85.1 (3.35)	17.7kg/39.0 lb		

MAGNETIC TOOLS & EQUIPMENT FOR FEEDING OPERATION
 LIFTING MAGNET
 MAGBORE™
 CHIP & SLUDGE CONVEYANCE EQUIPMENT
 ENVIRONMENTAL EQUIPMENT
 MAGNETIZER AND DEMAGNETIZER
 MAGNETIC EQUIPMENT FOR CONVEYANCE
 MAGNETIC SEPARATORS
 POWERFUL MAGNETIC SEPARATORS
 MEASURING TOOLS
 MEASURING INSTRUMENTS
 MAGNETIC MATERIALS

POWERFUL MAGNETIC SEPARATORS

Model PCMP POWERFUL MAGNETIC PIPE

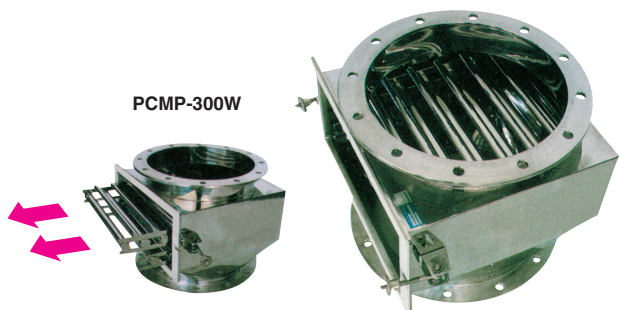

An example of fabrication of various types

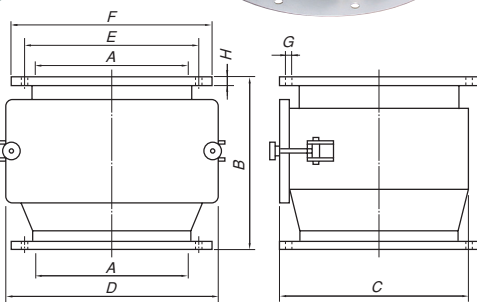
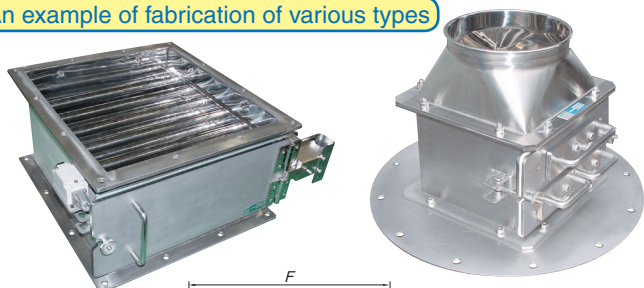

[Application]

These pipes are installed on the falling side of pneumatic feed lines and pipe passages having a relatively large diameter to remove iron from flowing powder and granular materials of food raw materials and chemical powder.

[Features]

- Models of various sizes are available to meet various diameters of pipes on which they are installed and required processing capacity.
- Powerful magnetic bars having a surface magnetic flux density of 0.8 T (8,000 G) or 1 T (10,000 G) or over are built in, that enables efficient collection of iron from flowing granular materials.
- A heat-resistant powerful version that can maintain its strong magnetic force without significant deterioration when used continuously in fluid up to 240°C is also available.
- Since permanent magnets that maintain a strong magnetic force almost perpetually are used, the running cost can be reduced significantly.

■ An example of usage : Spice raw materials, gunpowder, chemicals

An example of PCMP automatic discharge type

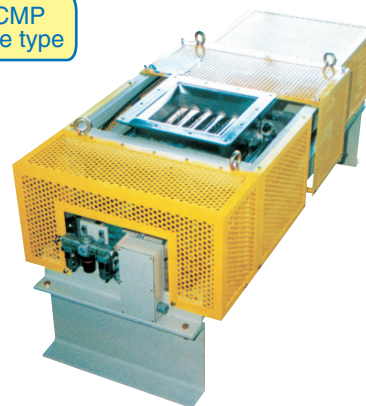

Gentle removal of iron from powder, fine and coarse particles without damaging or denaturing them.



Powerful type

[mm (in)]

Model	Material	Magnetic Bar		Processing Capacity	Dimensions								Working Temperature	Mass	
		Stage	Qty		Surface max. magnetic flux density	A	B	C	D	E	F	G			H
PCMP-200W	SUS 304	2	9	0.8T (8000G)	6m³/h	φ 220 (8.66)	360 (14.1)	269 (10.5)	296 (11.6)	280 (11.0)	320 (12.6)	φ 18 (0.70) × 8 (0.31)	8 (0.31)	Upper limit 80°C (176°F)	24kg/ 52 lb
PCMP-250W			10m³/h		φ 270 (10.6)	380 (14.9)	319 (12.5)	346 (13.6)	345 (13.5)	385 (15.2)	φ 18 (0.70) × 12 (0.47)				30kg/ 66 lb
PCMP-300W			14m³/h		φ 320 (12.6)	410 (16.1)	369 (14.5)	396 (15.5)	390 (15.3)	430 (16.9)		φ 18 (0.70) × 16 (0.62)			35kg/ 77 lb
PCMP-350W			18m³/h		φ 370 (14.5)	450 (17.7)	419 (16.5)	446 (17.5)	435 (17.1)	480 (18.9)					φ 18 (0.70) × 16 (0.62)
PCMP-400W			24m³/h		φ 420 (16.5)	470 (18.5)	469 (18.4)	496 (19.5)	495 (19.4)	540 (21.2)	47kg/ 103 lb				

*Flanges of special dimensions are also available according to the specifications of connection. *A type having the magnet part made of SUS316 and a type having one-stage magnet rack are also available.

Heat-resistant powerful type

[mm (in)]

Model	Material	Magnetic Bar		Processing Capacity	Dimensions								Working Temperature	Mass	
		Stage	Qty		Surface max. magnetic flux density	A	B	C	D	E	F	G			H
PCMP-T200W	SUS 304	2	9	0.8T (8000G)	6m³/h	φ 220 (8.66)	360 (14.1)	269 (10.5)	296 (11.6)	280 (11.0)	320 (12.6)	φ 18 (0.70) × 8 (0.31)	8 (0.31)	Upper limit 240°C (464°F)	24kg/ 52 lb
PCMP-T250W			10m³/h		φ 270 (10.6)	380 (14.9)	319 (12.5)	346 (13.6)	345 (13.5)	385 (15.2)	φ 18 (0.70) × 12 (0.47)				30kg/ 66 lb
PCMP-T300W			14m³/h		φ 320 (12.6)	410 (16.1)	369 (14.5)	396 (15.5)	390 (15.3)	430 (16.9)		φ 18 (0.70) × 16 (0.62)			35kg/ 77 lb
PCMP-T350W			18m³/h		φ 370 (14.5)	450 (17.7)	419 (16.5)	446 (17.5)	435 (17.1)	480 (18.9)					φ 18 (0.70) × 16 (0.62)
PCMP-T400W			24m³/h		φ 420 (16.5)	470 (18.5)	469 (18.4)	496 (19.5)	495 (19.4)	540 (21.2)	47kg/ 103 lb				

*Flanges of special dimensions are also available according to the specifications of connection. *A type having the magnet part made of SUS316 and a type having one-stage magnet rack are also available.

Super powerful type

[mm (in)]

Model	Material	Magnetic Bar		Processing Capacity	Dimensions								Working Temperature	Mass	
		Stage	Qty		Surface max. magnetic flux density	A	B	C	D	E	F	G			H
PCMP-A200W	SUS 304	2	9	1T (10000G)	6m³/h	φ 220 (8.66)	360 (14.1)	269 (10.5)	296 (11.6)	280 (11.0)	320 (12.6)	φ 18 (0.70) × 8 (0.31)	8 (0.31)	Upper limit 80°C (176°F)	24kg/ 52 lb
PCMP-A250W			10m³/h		φ 270 (10.6)	380 (14.9)	319 (12.5)	346 (13.6)	345 (13.5)	385 (15.2)	φ 18 (0.70) × 12 (0.47)				30kg/ 66 lb
PCMP-A300W			14m³/h		φ 320 (12.6)	410 (16.1)	369 (14.5)	396 (15.5)	390 (15.3)	430 (16.9)		φ 18 (0.70) × 16 (0.62)			35kg/ 77 lb
PCMP-A350W			18m³/h		φ 370 (14.5)	450 (17.7)	419 (16.5)	446 (17.5)	435 (17.1)	480 (18.9)					φ 18 (0.70) × 16 (0.62)
PCMP-A400W			24m³/h		φ 420 (16.5)	470 (18.5)	469 (18.4)	496 (19.5)	495 (19.4)	540 (21.2)	47kg/ 103 lb				

*Flanges of special dimensions are also available according to the specifications of connection. *A type having the magnet part made of SUS316 and a type having one-stage magnet rack are also available.

MAGNETIC TOOLS & EQUIPMENT FOR PNEUMATIC OPERATION
LIFTING MAGNET
MAGBORE*
CHP & SUDGE CONVEYANCE EQUIPMENT
ENVIRONMENTAL EQUIPMENT
MAGNETIZER AND DEMAGNETIZER
MAGNETIC EQUIPMENT FOR CONVEYANCE SEPARATORS
POWERFUL MAGNETIC SEPARATORS
MEASURING TOOLS
MEASURING INSTRUMENTS
MAGNETIC MATERIALS

Model **PCML**

L-TYPE MAGNETIC FILTER FOR LIQUID

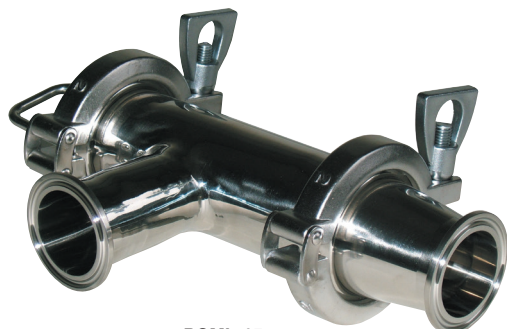

PCML-15

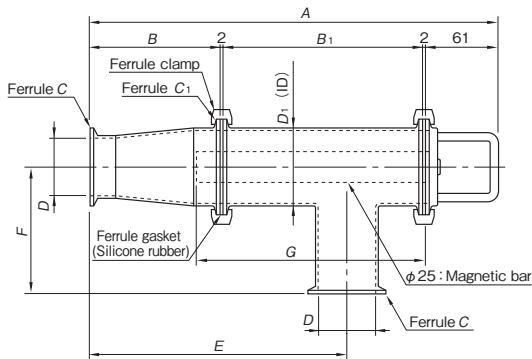

[Features]

- Suitable for a small amount (flow rate) to process.
- Simple construction for easy overhaul and cleaning.
- Compact and light weight, requiring little installation space.
- An example of usage: Dairy products, ketchup, sausage, honey, chili oil, fermented soybean *tare*

Powerful type

[mm (in)]

Model	Surface Material	Surface Finish	Surface Max. Magnetic Flux Density	Working Temperature	Pressure Resistance	Dimensions									Mass	
						A	B	B ₁	C	C ₁	D	D ₁	E	F		G
PCML-10			0.8T (8000G)	Upper limit 80°C (176°F)	500kPa (5kgf/cm ²)	259 (10.2)	55 (2.16)	139 (5.47)	1S	2S	23 (0.90)	47.8 (1.88)	139 (5.47)	72.5 (2.85)	152 (5.98)	Approx. 2.0kg/4.4 lb
PCML-15	SUS304	#400 buffed	0.8T (8000G) or over	80°C (176°F)	500kPa (5kgf/cm ²)	343 (13.5)	110 (4.33)	168 (6.61)	1.5S	2S	35.7 (1.41)	47.8 (1.88)	139 (5.47)	85.5 (3.36)	152 (5.98)	
PCML-20						343 (13.5)	110 (4.33)	168 (6.61)	2S	2.5S	47.8 (1.88)	59.5 (2.34)	217 (8.54)	103.5 (4.07)	192 (7.55)	

Heat-resistant powerful type

[mm (in)]

Model	Surface Material	Surface Finish	Surface Max. Magnetic Flux Density	Working Temperature	Pressure Resistance	Dimensions									Mass	
						A	B	B ₁	C	C ₁	D	D ₁	E	F		G
PCML-T10			0.8T (8000G)	Upper limit 150°C (302°F)	500kPa (5kgf/cm ²)	259 (10.2)	55 (2.16)	139 (5.47)	1S	2S	23 (0.90)	47.8 (1.88)	139 (5.47)	72.5 (2.85)	152 (5.98)	Approx. 2.0kg/4.4 lb
PCML-T15	SUS304	#400 buffed	0.8T (8000G) or over	150°C (302°F)	500kPa (5kgf/cm ²)	343 (13.5)	110 (4.33)	168 (6.61)	1.5S	2S	35.7 (1.41)	47.8 (1.88)	139 (5.47)	85.5 (3.36)	152 (5.98)	
PCML-T20						343 (13.5)	110 (4.33)	168 (6.61)	2S	2.5S	47.8 (1.88)	59.5 (2.34)	217 (8.54)	103.5 (4.07)	192 (7.55)	

Super powerful type

[mm (in)]

Model	Surface Material	Surface Finish	Surface Max. Magnetic Flux Density	Working Temperature	Pressure Resistance	Dimensions									Mass	
						A	B	B ₁	C	C ₁	D	D ₁	E	F		G
PCML-A10			1T (10000G)	Upper limit 80°C (176°F)	500kPa (5kgf/cm ²)	259 (10.2)	55 (2.16)	139 (5.47)	1S	2S	23 (0.90)	47.8 (1.88)	139 (5.47)	72.5 (2.85)	152 (5.98)	Approx. 2.0kg/4.4 lb
PCML-A15	SUS304	#400 buffed	1T (10000G) or over	80°C (176°F)	500kPa (5kgf/cm ²)	343 (13.5)	110 (4.33)	168 (6.61)	1.5S	2S	35.7 (1.41)	47.8 (1.88)	139 (5.47)	85.5 (3.36)	152 (5.98)	
PCML-A20						343 (13.5)	110 (4.33)	168 (6.61)	2S	2.5S	47.8 (1.88)	59.5 (2.34)	217 (8.54)	103.5 (4.07)	192 (7.55)	

Model **PCML-S**

POWERFUL MAGNETIC FILTER FOR RESIN MOLDING



PCML-15-S

[Application]

Attracts and removes iron mixed in resin (powder, particles) by a strong permanent magnet.

[Features]

- Simple construction for easy overhaul and cleaning.
- Compact and light weight, requiring little installation space.
- A powerful magnet having a property value of 1.2 T (12,000 G) or over is incorporated and the surface maximum magnetic flux density is 0.8 T (8,000 G) or over attracts and removes iron mixed in resin.
- Since a permanent magnet that maintains a strong magnetic force almost perpetually is used, the running cost can be reduced significantly.

An example of PCML special fabrication

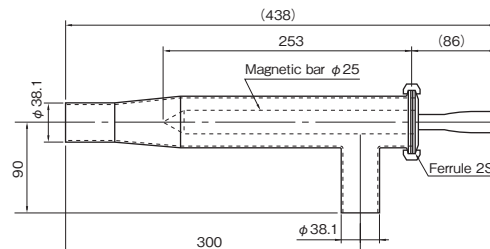
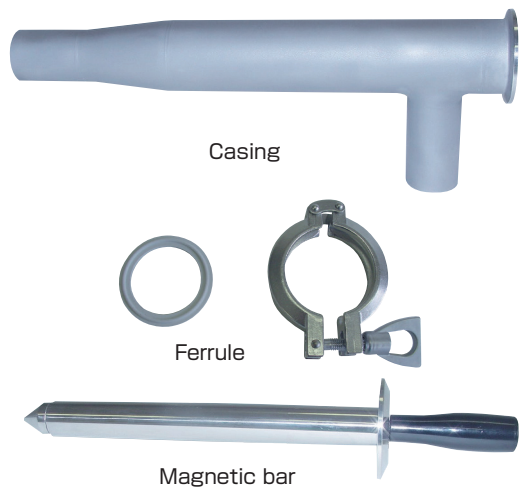

Model	Surface Material	Surface Finish		Surface Max. Magnetic Flux Density	Working Temperature	Mass
		Magnetic bar	Casing			
PCML-15-S	SUS304	#200 buffed	Inside: #200 buffed Outside: Pickled	0.8 T (8000 G) or over	Upper limit 80°C (176°F)	Approx. 2kg/4.4 lb

MAGNETIC TOOLS & EQUIPMENT
 PERFORMING OPERATION
 LIFTING
 MAGNET
 MAGBORE*
 MAGNETIC EQUIPMENT
 CHIP & SLUDGE
 CONVEYANCE EQUIPMENT
 MAGNETIZER AND ENVIRONMENTAL
 EQUIPMENT
 MAGNETIZER AND
 DEMAGNETIZER
 MAGNETIC EQUIPMENT
 FOR CONVEYANCE
 MAGNETIC
 SEPARATORS
 POWERFUL MAGNETIC
 SEPARATORS
 MEASURING
 TOOLS
 MAGNETIC
 MATERIALS
 INSTRUMENTS

POWERFUL MAGNETIC SEPARATORS

Model PCMS STRAIGHT TYPE MAGNETIC FILTER FOR LIQUID

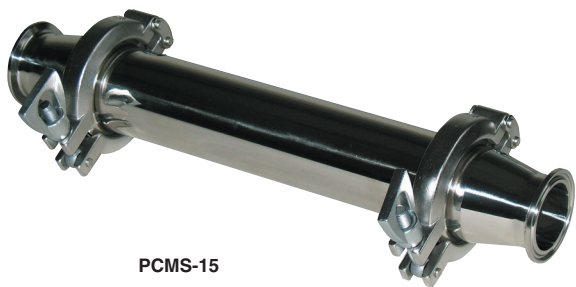

PCMS-15

[Features]

- Recommended for operations where the amount (flow rate) of materials to process is small.
- Simple construction for easy overhaul and cleaning.
- Compact and light weight, requiring little space.
- An example of usage: Mayonnaise, steak sauce, paste

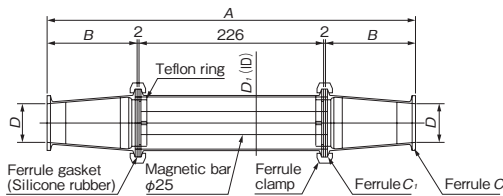

Powerful type / Heat-resistant powerful type / Super powerful type

[mm (in)]

Model			Surface Material	Surface Finish	Pressure Resistance	Dimensions					Working Temperature			Mass	
Powerful	Heat-resistant powerful	Super powerful				A	B	C	C ₁	D	D ₁	Surface Max. Magnetic Flux Density	Powerful		Heat-resistant powerful
PCMS-10	PCMS-T10	PCMS-A10	SUS304	#400 buffed	500kPa (5kgf/cm ²)	340 (13.3)	55 (2.16)	1S	2S	φ23 (0.90)	φ47.8 (1.88)	Upper limit 80°C (176° F)	Upper limit 150°C (302° F)	Upper limit 80°C (176° F)	Approx. 2.5kg/5.51 lb
PCMS-15	PCMS-T15	PCMS-A15				450 (17.7)	110 (4.33)	1.5S	2.5S	φ35.7 (1.41)	φ59.5 (2.34)	0.8T (8000G) or over	0.8T (8000G) or over	1T (10000G) or over	
PCMS-20	PCMS-T20	PCMS-A20													

Model PCMY MAGNETIC FILTER FOR LIQUID

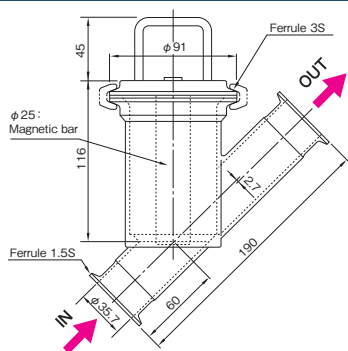
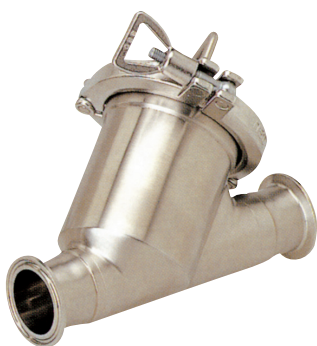

[Features]

- A Y-type filter that can be used for straight piping. The magnetic bar can be cleaned easily.
- An example of usage: Noodle soup, sauce, syrup

Model	Surface Material	Surface Finish	Surface Max. Magnetic Flux Density	Working Temperature	Pressure Resistance	Mass
PCMY-15	SUS304	#400 buffed	0.8 T (8000 G) or over	Upper limit 80°C (176° F)	1,000kPa (10kgf/cm ²)	Approx. 4kg/8.8 lb
PCMY-T15	SCS13			Upper limit 150°C (302° F)		

Model CPM TUBULAR MAGNETIC SEPARATOR

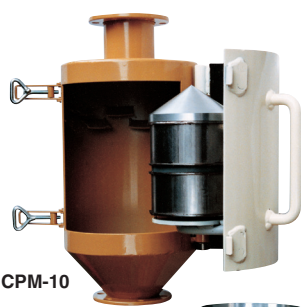

CPM-10

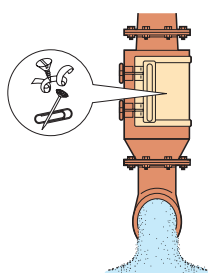

CPM sanitary specification

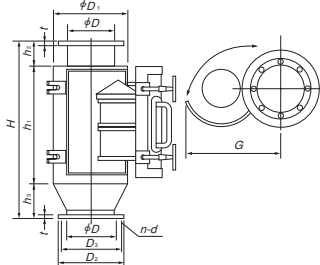

[Application]

A tubular separator incorporating a powerful columnar permanent magnet. When this separator is installed in a system to flow such nonmagnetic substances as powder and granular materials, mixed iron pieces, etc. can be removed. This separator has a construction suitable for vertical falling flow operations.

[Features]

- Eight types are available by cylinder sizes to meet various mounting shapes.
- The magnet is housed in a robust steel tube for protection against impacts by powder and granular materials.
- The opening hatch facilitates removal of iron pieces.
- While the iron-removal rate is very high, the installation cost is low and almost no running cost is required.
- The transfer lines and processing equipment are protected against damage by iron pieces.
- Possible spark formation of powder and granular materials can be prevented.
- The quality and purity can be increased and reliability can be enhanced.

[mm (in)]

Model	Processing Capacity	Dimensions										Mass	
		φD	φD ₁	H	h ₁	h ₂	h ₃	φD ₂	D ₃	n-d	G		
CPM-5	1 m ³ /h	61 (2.40)	145 (5.70)	310 (12.2)	195 (7.67)	50 (1.96)	65 (2.55)	130 (5.11)	105 (4.13)			200 (7.87)	6kg/13 lb
CPM-10	2.5m ³ /h	102 (4.01)	220 (8.66)	570 (22.4)	370 (14.5)	70 (2.75)	130 (5.11)	190 (7.48)	155 (6.10)	6-φ10 (0.39)		300 (11.8)	12.5kg/28 lb
CPM-15	6 m ³ /h	165 (6.49)	275 (10.8)	680 (26.7)	430 (16.9)		150 (5.90)	265 (10.4)	230 (9.05)			310 (12.2)	22kg/48 lb
CPM-20	10 m ³ /h	216 (8.50)	345 (13.5)	790 (31.1)	520 (20.4)		170 (6.69)	320 (12.6)	280 (11.0)	8-φ10 (0.39)		390 (15.3)	30kg/66 lb
CPM-25	15 m ³ /h	267 (10.5)	435 (17.1)	950 (37.4)	580 (22.8)		270 (10.6)	385 (15.2)	345 (13.5)	12-φ10 (0.39)	8 (0.31)	485 (19.1)	45kg/99 lb
CPM-30	20 m ³ /h	319 (12.5)	485 (19.1)	1000 (39.4)	600 (23.6)	100 (3.93)	430 (16.9)	390 (15.3)				560 (22.0)	58kg/127 lb
CPM-40	35 m ³ /h	406 (15.9)	620 (24.4)	1100 (43.3)	700 (27.5)		300 (11.8)	540 (21.2)	495 (19.4)	12-φ14 (0.55)		715 (28.2)	85kg/187 lb
CPM-50	55 m ³ /h	508 (20.0)	780 (30.7)	1200 (47.2)	780 (30.7)		320 (12.6)	655 (25.7)	605 (23.8)			885 (34.8)	110kg/242 lb

*A sanitary version is also available upon request.

Model **PCMN** SANITARY PLATE MAGNET

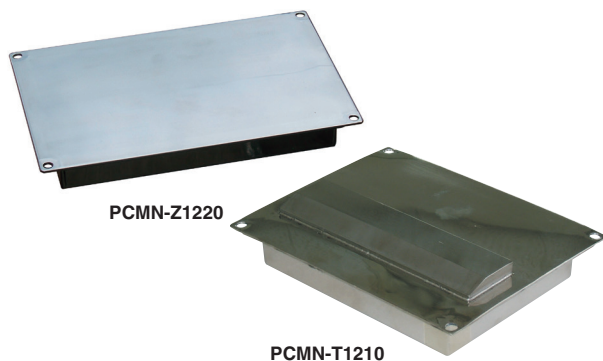

[Application]

Flat type

This type is installed in critical places of nonmagnetic ducts to catch iron in flowing raw materials. When the magnet is removed after raw materials have passed, the magnetic force is canceled and only iron can be collected.

[Features]

- High grade finish of sanitary specification.
- These magnets are completely enclosed and therefore can be installed in liquid.
- Powerful as a rare earth magnet having a property value of 1.2 T is built in.
- The employment of a magnet layout having a wide attractive area produces a magnetic flux density that is 20% greater than that of the flat type. (PCMN-Z)

Type with template

This type is installed on chutes and hoppers to separate/collect iron in granular materials such as foods and chemicals. The template holds caught iron against the pressure of flowing raw materials and keeps accumulating such iron.

Powerful plate magnet

Flat type Type with template

[mm (in.)]

Model		Dimensions		Material		Surface Finish	Built-in Permanent Magnet	Surface Max. Magnetic Flux Density		Working Temp. Upper Limit	Mass	
Flat	Template	A	B	Main unit	Template (PCMN-T)			Flat	Template		Flat	Template
PCMN-1205	PCMN-T1205	85 (3.34)	55 (2.16)			#400 buffed	Nd rare earth type Property value 1.2 T (12,000 G)	0.4T	0.8T	80°C (176° F)	1.8kg/3.96 lb	2.0kg/4.40 lb
PCMN-1210	PCMN-T1210	135 (5.31)	105 (4.13)								3.1kg/6.83 lb	3.4kg/7.49 lb
PCMN-1215	PCMN-T1215	185 (7.28)	156 (6.14)								5.0kg/11.0 lb	5.5kg/12.1 lb
PCMN-1220	PCMN-T1220	235 (9.25)	207 (8.15)	SUS 304	SUS 430						6.0kg/13.2 lb	6.6kg/14.5 lb
PCMN-1225	PCMN-T1225	290 (11.4)	258 (10.1)								7.1kg/15.6 lb	7.9kg/17.4 lb
PCMN-1230	PCMN-T1230	340 (13.3)	309 (12.1)								8.6kg/18.9 lb	9.5kg/21.0 lb

*These magnets can be used in liquids that do not cause chemical reaction with the material of the magnets.

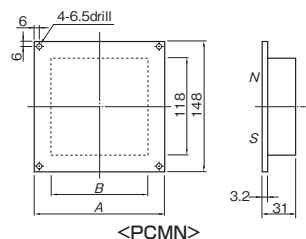

Type of magnet staggered arrangement

[mm (in.)]

Model	Dimensions		Material	Surface Finish	Built-in Permanent Magnet	Surface Max. Magnetic Flux Density	Working Temp. Upper Limit	Mass
	A	B						
PCMN-Z1212	150 (5.90)	120 (4.72)	SUS 304	#400 buffed	Nd rare earth Type Property value 1.2 T (12,000 G)	0.5T (5000G)	80°C (176° F)	3.5kg/7.71 lb
PCMN-Z1220	230 (9.05)	200 (7.87)						5.5kg/12.1 lb
PCMN-Z1225	280 (11.0)	250 (9.84)						6.5kg/14.3 lb
PCMN-Z1230	334 (13.1)	304 (11.9)						8.0kg/17.6 lb

*These magnets can be used in liquids that do not cause chemical reaction with the material of the magnets.

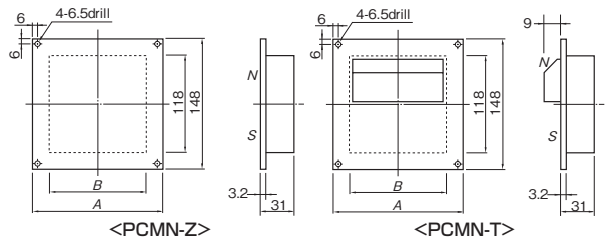

Model **PCMN-HU** SUSPENDED POWERFUL PLATE MAGNET

[Application]

These magnets are suspended above a conveyor to attract and remove iron pieces, etc. from foods being conveyed.

[Features]

- These magnets are a suspension version of the conventional powerful plate magnet and can easily be used in liquid.
- Four eyebolts are included

Powerful plate magnet

Suspension type

[mm (in.)]

Model	Dimensions		Material	Surface Finish	Built-in Permanent Magnet	Surface Max. Magnetic Flux Density	Working Temp. Upper Limit	Mass
	A	B						
PCMN-HU1205	97 (3.81)	57 (2.24)	SUS304	#400 buffed	Nd rare earth type Property value 1.2 T (12,000 G)	0.4T	80°C (176° F)	2.3kg/5.07 lb
PCMN-HU1210	148 (5.82)	108 (4.25)						3.8kg/8.39 lb
PCMN-HU1215	199 (7.83)	159 (6.26)						6.0kg/13.2 lb
PCMN-HU1220	249 (9.80)	209 (8.22)						7.1kg/15.6 lb
PCMN-HU1225	300 (11.8)	260 (10.2)						8.2kg/18.1 lb
PCMN-HU1230	351 (13.8)	311 (12.2)						9.9kg/21.8 lb

*These magnets can be used in liquids that do not cause chemical reaction with the material of the magnets.

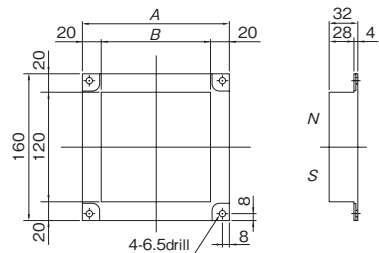

Model **PCMN-TF** PLATE MAGNET WITH WEAR-RESISTANT COATING

Miracle 1.4 Tesla (14,000 Gauss) realized

[Features]

- A uniform magnetic field is produced over the entire pole having a certain width.
- A magnetic flux density of 1.4 Tesla (14,000 Gauss) far exceeding conventional powerful magnets has been realized!
- Compared with the N-S-N-S structure of magnetic bars, the effective magnetic pole is 100% to provide a reliable separation effect.
- The employment of a sharp gradient construction enables it to continuously catch fine iron powder that cannot be caught by conventional iron-removing magnets.
- These magnets have been treated by KANETEC's original surface treatment technology to make them highly resistant to wear and corrosion.

[mm (in.)]

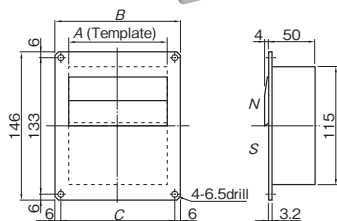
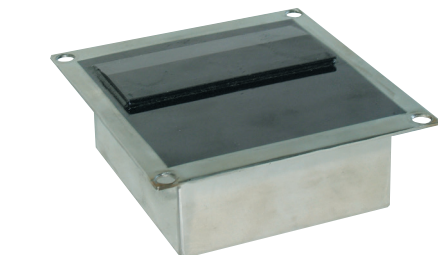

Model	Dimensions			Material	Surface Finish	Built-in Permanent Magnet	Surface Max. Magnetic Flux Density	Working Temp. Upper Limit	Mass
	A	B	C						
PCMN-TF1205	55 (2.16)	85 (3.34)	73 (2.87)	SUS304	#400 buffed	Nd rare earth type Property value 1.2 T (12,000 G)	1.4T (14000G)	80°C (176° F)	2.5kg/5.51 lb
PCMN-TF1210	105 (4.13)	135 (5.31)	123 (4.84)						5.0kg/11.0 lb
PCMN-TF1215	156 (6.14)	185 (7.28)	173 (6.81)						7.5kg/16.5 lb
PCMN-TF1220	207 (8.15)	235 (9.25)	223 (8.77)						10.0kg/22.0 lb
PCMN-TF1230	309 (12.1)	340 (13.3)	328 (12.9)						15.0kg/33.0 lb

MAGNETIC TOOLS & EQUIPMENT FOR MEDICAL OPERATION
LIFTING MAGNET
MAGBORE™
MAGNETIC EQUIPMENT FOR CONVEYANCE EQUIPMENT
MAGNETIZER AND ENVIRONMENTAL DEMAGNETIZER EQUIPMENT
MAGNETIC EQUIPMENT FOR CONVEYANCE
MAGNETIC SEPARATORS
POWERFUL MAGNETIC SEPARATORS
MEASURING INSTRUMENTS TOOLS
MAGNETIC MATERIALS

Model PCMD POWERFUL PERMANENT MAGNETIC DRUM

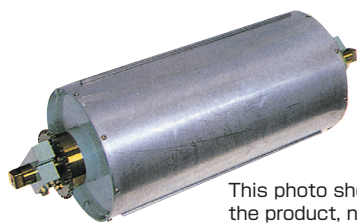

This photo shows an image of the product, not Model PCMD.

An example of PCMD-1630 casing

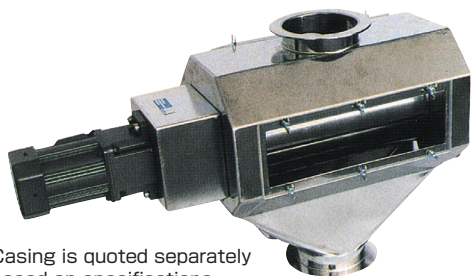

Casing is quoted separately based on specifications.

[Application]

This drum is installed in a system or casing and driven by a motor at a low speed to continuously separate and sort out magnetic fine pieces from raw materials fed. This drum is suitable for removing iron mixed in materials in processes of threshing, cleaning and processing rice.

[Features]

- Types of various sizes are available according to specifications of mounting equipment and required capacity.
- These drums employ a powerful rare earth magnet having a property value of 1.2 T (12,000 G) or over and the surface maximum magnetic flux density is 0.35 T (3,500 G) or over to realize a type that is most powerful in the drum series.
- Since a permanent magnet of which the powerful magnetic force is maintained for almost perpetually is used, the running cost can be reduced significantly.

- An example of usage: Cleaned rice, barley/wheat, beans, coffee beans

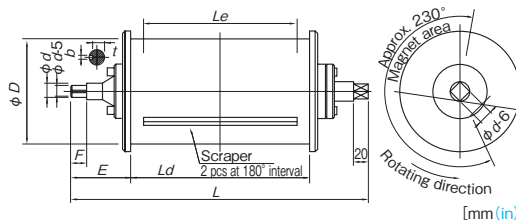

Model	Max. Processing Capacity	Revolution	Drive Motor	Working Temp. Upper Limit	Drum Dia.	Effective Width	Drum Width	Dimensions			Shaft Dia.	Keyway	Mass
					ϕD	Le	Ld	L	E	F	ϕd	$b \times t$	
PCMD-1630	3.0m ³ /h	Optimum range 20 - 60 rpm	Optimum capacity 0.1 kW	80°C (176°F)	$\phi 165$ (6.49)	300(11.8)	320(12.6)	535(21.0)	110(4.33)	25(0.98)	$\phi 20$ (0.78)	5(0.19)×12(0.47)	Approx. 25kg/55.1 lb
PCMD-2135	4.5m ³ /h				$\phi 216$ (8.50)	350(13.7)	370(14.5)	600(23.6)	115(4.52)	30(1.18)	$\phi 25$ (0.98)	6(0.23)×16.5(0.65)	Approx. 37kg/81.5 lb
PCMD-2640	6.0m ³ /h				$\phi 267$ (10.5)	390(15.3)	420(16.5)	660(25.9)	130(5.11)	38(1.49)	$\phi 30$ (1.18)	8(0.31)×21(0.82)	Approx. 50kg/110 lb

Model PCMR POWERFUL PULLEY TYPE LOCUS SEPARATOR

Removes weak magnetic fine particles from powder!!



PCMR-20A

An example of special fabrication

- An example of usage: Rice, barley/wheat, beans, spice, coffee, tea, konbu (kelp), various dry food materials, candy materials, chemical materials, chemical products, desiccating agent, feed, plastic materials and other various granular materials.

[Application]

This separator is installed in the preceding stage of processing dry granular materials, spice materials and chemicals to separate and remove weak magnetic fine particles by a strong permanent magnet.

[Features]

- The permanent magnetic pulley employs a high-performance rare earth magnet. Weak magnetic substances such as friction particles of stainless steel (SUS304) can be removed.
- Short length and compact, requiring a small installation space.
- The original construction facilitates belt replacement.
- The conveyor system for incorporation into lines.
- A version of antistatic belt specification is also available.

Model	Max. Processing Capacity	Drive Motor	Belt Speed	Dimensions			Mass
				Width	Length	Height	
PCMR-10A	0.8m ³ /h	0.09kW	30-60 m/min.	100(3.93)	830(32.6)	688(27.0)	50kg/110 lb
PCMR-20A	1.6m ³ /h			200(7.87)			65kg/143 lb
PCMR-30A	2.4m ³ /h			300(11.8)			80kg/176 lb

※The width up to 600 mm is possible.

Model PCMI OPPOSING-POLE TYPE POWERFUL MAGNETIC SEPARATOR

Powerful! 2-Tesla (20,000 Gauss) magnetic field never misses magnetic substances that cannot be collected by conventional magnetic bars!



PCMI-10

<A concept of catching magnetic substances>

- Foods, chemical powder
- Iron powder, SUS powder

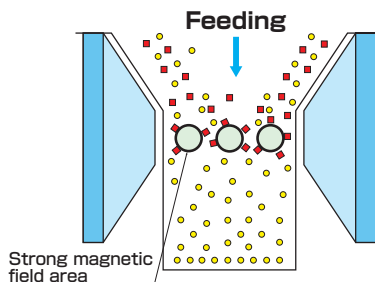

[Features]

- A uniform magnetic field is produced over the entire poles having a certain width.
- Since materials to process always pass through the highly magnetic area, magnetic substances are completely separated.
- Compared with the N-S-N-S structure of magnetic bars, the effective magnetic pole is 100% to provide a reliable separation effect.
- Most suitable for separating/collecting and high-grade screening of fine iron powder, stainless steel powder and very fine wear particles from a small amount of non-sticky powder. (A fixed amount vibration feeder included.)

An example of processing

Materials to Process	Grain Size [μm]	Grain Size [kg/h]
Non-sticky powder	300-500	75
Konjak flour	40-600	120

Model	Dimensions			Materials Passing Area	Power Source	Mass
	Width	Depth	Height			
PCMI-10	180(7.08)	480(18.9)	405(15.9)	W1.5(0.05) × L100(3.93) × 4 places	100 VAC	55kg/121 lb